

Ezi-SERVO[®]

Closed Loop Stepping System

- Closed Loop System
- No Gain Tuning
- No Hunting
- High Resolution
- Fast Response

ST



C **UL** US **CE** **RoHS**
COMPLIANT

FASTTECH



FASTECH

Ezi-SERVO[®] ST

Closed Loop Stepping System



2

No Gain Tuning

Conventional servo systems, to ensure machine performance, smoothness, positional error and low servo noise, require the adjustment of its servo's gains as an initial crucial step. Even systems that employ auto-tuning require manual tweaking after the system is installed, especially if more than one axis are interdependent. Ezi-SERVO[®] employs the best characteristics of stepper and closed loop motion controls and algorithms to eliminate the need of tedious gain tuning required for conventional closed loop servo systems. This means that Ezi-SERVO[®] is optimized for the application and ready to work right out of the box! The Ezi-SERVO[®] system employs the unique characteristics of the closed loop stepping motor control, eliminating these cumbersome steps and giving the engineer a high performance servo system without wasting setup time. Ezi-SERVO[®] is especially well suited for low stiffness loads (for example, a belt and pulley system) that sometimes require conventional servo systems to inertia match with the added expense and bulk of a gearbox. Ezi-SERVO[®] also performs exceptionally, even under heavy loads and high speeds!

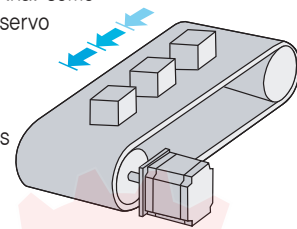

3

No Hunting

Traditional servo motor drives overshoot their position and try to correct by overshooting the opposite direction, especially in high gain applications. This is called null hunt and is especially prevalent in systems that the break away or static friction is significantly higher than the running friction. The cure is lowering the gain, which affects accuracy or using Ezi-SERVO[®] Motion Control System! Ezi-SERVO[®] utilizes the unique characteristics of stepping motors and locks itself into the desired target position, eliminating Null Hunt. This feature is especially useful in applications such as nanotech manufacturing, semiconductor fabrication, vision systems and ink jet printing in which system oscillation and vibration could be a problem.

1

Closed Loop System

Ezi-SERVO[®] is an innovative closed loop stepping motor and controller that utilizes a high-resolution motor mounted encoder to constantly monitor the motor shaft position. The encoder feedback feature allows the Ezi-SERVO[®] to update the current motor shaft position information every 25 micro seconds. This allows the Ezi-SERVO[®] drive to compensate for the loss of position, ensuring accurate positioning. For example, due to a sudden load change, a conventional stepper motor and drive could lose a step creating a positioning error and a great deal of cost to the end user!

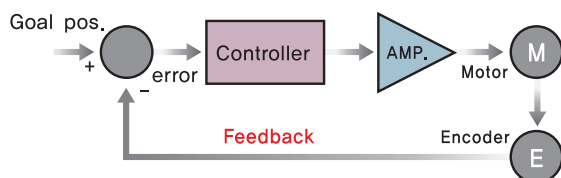

Complete stop

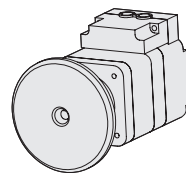

Hunting

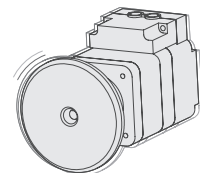

Ezi-SERVO

Servo motor

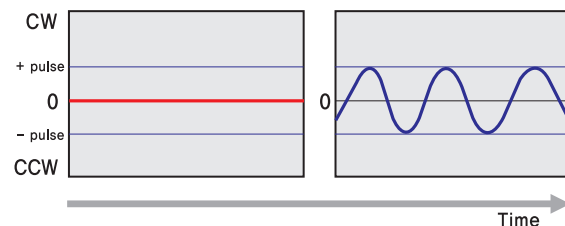

4 Smooth and Accurate

Ezi-SERVO® is a high-precision servo drive, using a high-resolution encoder with 32,000 pulses/revolution. Unlike a conventional Microstep drive, the on-board high performance DSP (Digital Signal Processor) performs vector control and filtering, producing a smooth rotational control with minimum ripples.

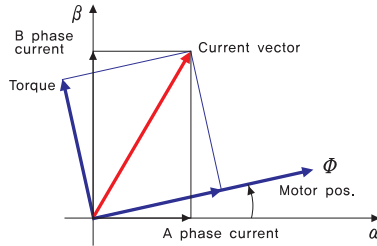

5 Fast Response

Similar to conventional stepping motors, Ezi-SERVO® instantly synchronizes with command pulses providing fast positional response. Ezi-SERVO® is the optimum choice when zero-speed stability and rapid motions within a short distance are required. Traditional servo motor systems have a natural delay between the commanding input signals and the resultant motion because of the constant monitoring of the current position, necessitating a waiting time until it settles, called settling time.

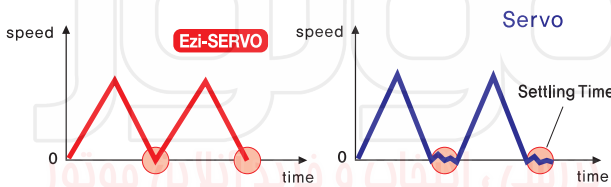

6 High Resolution

The unit of the position command can be divided precisely. (Max. 32,000 pulses/revolution)

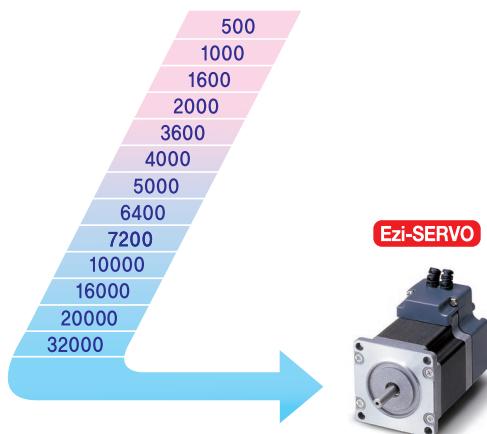

7 High Torque

Compared with common step motors and drives, Ezi-SERVO® motion control systems can maintain a high torque state over relatively long period of time. This means that Ezi-SERVO continuously operates without loss of position under 100% of the load. Unlike conventional Microstep drives, Ezi-SERVO® exploits continuous high-torque operation during high-speed motion due to its innovative optimum current phase control.

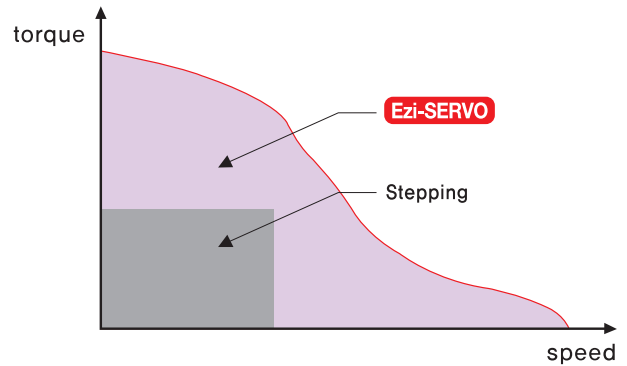

8 High Speed

The Ezi-SERVO® functions well at high speed without the loss of Synchronism or positioning error. Ezi-SERVO®'s ability of continuous monitoring of current position enables the stepping motor to generate high-torque, even under a 100% load condition.

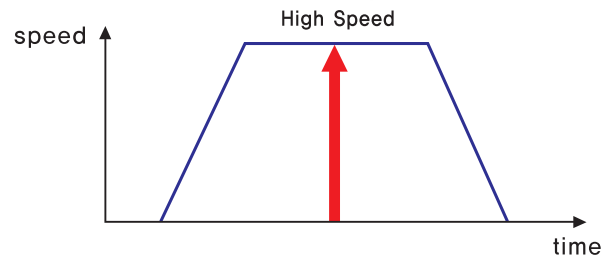

● Part Numbering

Ezi-SERVO-42S-A-□

Closed Loop Stepping System Name

Motor Flange Size

20 : 20mm
28 : 28mm
42 : 42mm
56 : 56mm
60 : 60mm
86 : 86mm

Motor Length

S : Single
M : Middle
L : Large
XL: Extra Large

Encoder Resolution

A : 10,000/Rev.
B : 20,000/Rev.
C : 32,000/Rev.
D : 16,000/Rev.
F : 4,000/Rev.

User Code

● Combination List of Ezi-SERVO

Unit Part Number	Motor Model Number	Drive Model Number
Ezi-SERVO-20M-F	EzM-20M-F	EzS-PD-20M-F
Ezi-SERVO-20L-F	EzM-20L-F	EzS-PD-20L-F
Ezi-SERVO-28S-D	EzM-28S-D	EzS-PD-28S-D
Ezi-SERVO-28M-D	EzM-28M-D	EzS-PD-28M-D
Ezi-SERVO-28L-D	EzM-28L-D	EzS-PD-28L-D
Ezi-SERVO-42S-A	EzM-42S-A	EzS-PD-42S-A
Ezi-SERVO-42S-B	EzM-42S-B	EzS-PD-42S-B
Ezi-SERVO-42S-C	EzM-42S-C	EzS-PD-42S-C
Ezi-SERVO-42M-A	EzM-42M-A	EzS-PD-42M-A
Ezi-SERVO-42M-B	EzM-42M-B	EzS-PD-42M-B
Ezi-SERVO-42M-C	EzM-42M-C	EzS-PD-42M-C
Ezi-SERVO-42L-A	EzM-42L-A	EzS-PD-42L-A
Ezi-SERVO-42L-B	EzM-42L-B	EzS-PD-42L-B
Ezi-SERVO-42L-C	EzM-42L-C	EzS-PD-42L-C
Ezi-SERVO-42XL-A	EzM-42XL-A	EzS-PD-42XL-A
Ezi-SERVO-42XL-B	EzM-42XL-B	EzS-PD-42XL-B
Ezi-SERVO-42XL-C	EzM-42XL-C	EzS-PD-42XL-C
Ezi-SERVO-56S-A	EzM-56S-A	EzS-PD-56S-A
Ezi-SERVO-56S-B	EzM-56S-B	EzS-PD-56S-B
Ezi-SERVO-56S-C	EzM-56S-C	EzS-PD-56S-C
Ezi-SERVO-56M-A	EzM-56M-A	EzS-PD-56M-A
Ezi-SERVO-56M-B	EzM-56M-B	EzS-PD-56M-B
Ezi-SERVO-56M-C	EzM-56M-C	EzS-PD-56M-C
Ezi-SERVO-56L-A	EzM-56L-A	EzS-PD-56L-A
Ezi-SERVO-56L-B	EzM-56L-B	EzS-PD-56L-B
Ezi-SERVO-56L-C	EzM-56L-C	EzS-PD-56L-C
Ezi-SERVO-60S-A	EzM-60S-A	EzS-PD-60S-A
Ezi-SERVO-60S-B	EzM-60S-B	EzS-PD-60S-B
Ezi-SERVO-60S-C	EzM-60S-C	EzS-PD-60S-C
Ezi-SERVO-60M-A	EzM-60M-A	EzS-PD-60M-A
Ezi-SERVO-60M-B	EzM-60M-B	EzS-PD-60M-B
Ezi-SERVO-60M-C	EzM-60M-C	EzS-PD-60M-C
Ezi-SERVO-60L-A	EzM-60L-A	EzS-PD-60L-A
Ezi-SERVO-60L-B	EzM-60L-B	EzS-PD-60L-B
Ezi-SERVO-60L-C	EzM-60L-C	EzS-PD-60L-C
Ezi-SERVO-86M-A	EzM-86M-A	EzS-PD-86M-A
Ezi-SERVO-86L-A	EzM-86L-A	EzS-PD-86L-A
Ezi-SERVO-86XL-A	EzM-86XL-A	EzS-PD-86XL-A

بررسی، انتخاب و خرید آنلاین موتور

● Advantages over Open-loop Control Stepping Drive

1. Reliable positioning without loss of synchronism.
2. Holding stable position and automatically recovering to the original position even after experiencing positioning error due to external forces, such as mechanical vibration or vertical positional holding.
3. Ezi-SERVO® utilizes 100% of the full range of rated motor torque, contrary to a conventional open-loop stepping driver that can use up to 50% of the rated motor torque due to the loss of synchronism.
4. Capability to operate at high speed due to load-dependant current control, open-loop stepper drivers use a constant current control at all speed ranges without considering load variations.

● Advantages over Servo Motor Controller

1. No gain tuning (Automatic adjustment of gain in response to a load change.)
2. Maintains the stable holding position without oscillation after completing positioning.
3. Fast positioning due to the independent control by on-board DSP.
4. Continuous operation during rapid short-stroke movement due to instantaneous positioning.

● Specifications

Motor Model	EzM-20 series	EzM-28 series	EzM-42 series	EzM-56 series	EzM-60 series	EzM-86 series
Driver Model	EzS-PD-20 series	EzS-PD-28 series	EzS-PD-42 series	EzS-PD-56 series	EzS-PD-60 series	EzS-PD-86 series
Input Voltage	24VDC \pm 10%	24VDC \pm 10%	24VDC \pm 10%	24VDC \pm 10%	24VDC \pm 10%	40~70VDC
Control Method	Closed loop control with 32bit DSP					
Current Consumption	Max 500mA (Except motor current)					
Operating Condition	Ambient Temperature	In Use : 0~55°C In Storage : -20~70°C				
	Humidity	In Use : 35~85% (Non-Condensing) In Storage : 10~90% (Non-Condensing)				
	Vib. Resist.	0.5G				
Function	Rotation Speed	0~3000rpm				
	Resolution(P/R)	4000/Rev. Encoder model : 500, 1000, 1600, 2000, 3600, 5000, 6400, 7200, 10000, 4000 10000/Rev. Encoder model : 500, 1000, 1600, 2000, 3600, 5000, 6400, 7200, 10000 16000/Rev. Encoder model : 500, 1000, 1600, 2000, 3600, 5000, 6400, 7200, 10000, 16000 20000/Rev. Encoder model : 500, 1000, 1600, 2000, 3600, 5000, 6400, 7200, 10000, 20000 32000/Rev. Encoder model : 500, 1000, 1600, 2000, 3600, 5000, 6400, 7200, 10000, 32000 (Selectable with Rotary switch)				
	Max. Input Pulse Frequency	500KHz (Duty 50%)				
	Protection Functions	Over current, Over speed, Position tracking error, Over load, Over temperature, Over regenerated voltage, Motor connect error, Encoder connect error, Motor voltage error, Inposition error, System error, ROM error, Input voltage error, Position overflow error				
	LED Display	Power status, Alarm status, In-Position status, Servo On status				
	In-Position Selection	0~F(Selectable with Rotary switch)				
	Position Gain Selection	0~F(Selectable with Rotary switch)				
	Pulse Input Method	1-Pulse / 2-Pulse (Selectable with DIP switch)				
	Rotational Direction	CW / CCW (Selectable with DIP switch)				
	Speed/Position Control Command	Pulse train input				
	I/O Signals	Input Signals	Position command pulse, Servo On/Off, Alarm reset (Photocoupler input)			
Output Signals		In-Position, Alarm (Photocoupler output) Encoder signal(A+, A-, B+, B-, Z+, Z-, 26C31 of Equivalent), (Line Driver output)				

FASTECH Ezi-SERVO

● Drive Dimension [mm]

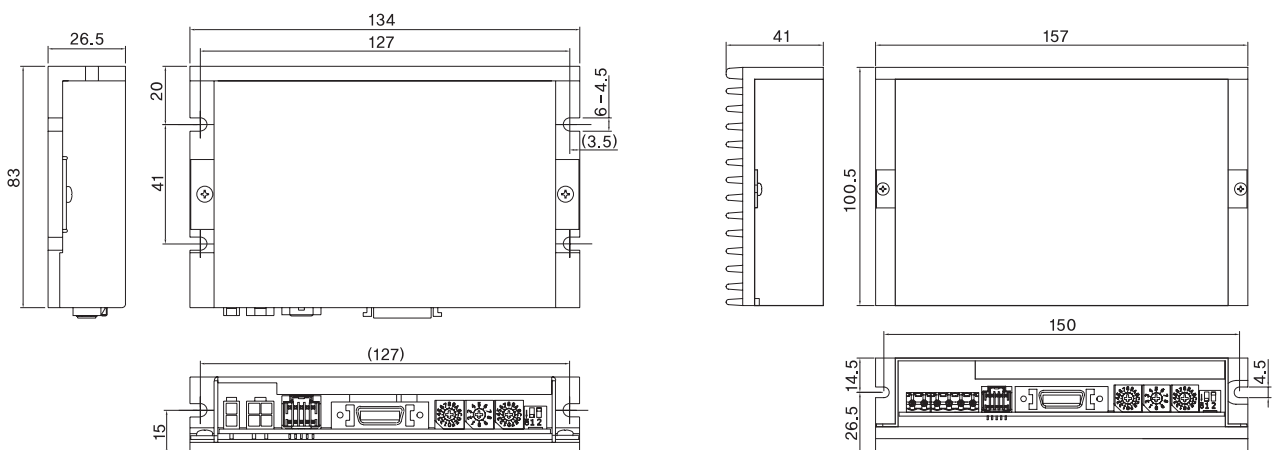

※Only for 86mm motor drive (EzS-PD-86 series)

● Motor Specifications

M O D E L		UNIT	EzM-20M-F	EzM-20L-F
DRIVE METHOD		----	BI-POLAR	BI-POLAR
NUMBER OF PHASES		----	2	2
VOLTAGE		VDC	2,9	2,25
CURRENT per PHASE		A	0,5	0,5
RESISTANCE per PHASE		Ohm	5,8	5,5
INDUCTANCE per PHASE		mH	2,5	5
HOLDING TORQUE		N · m	0,018	0,03
ROTOR INERTIA		$g \cdot cm^2$	2,5	3,3
WEIGHTS		g	50	80
LENGTH (L)		mm	28	38
ALLOWABLE OVERHUNG LOAD (DISTANCE FROM END OF SHAFT)	3mm	N	18	18
	8mm		30	30
ALLOWABLE THRUST LOAD		N	Lower than motor weight	
INSULATION RESISTANCE		MOhm	100min. (at 500VDC)	
INSULATION CLASS		----	CLASS B (130°C)	
OPERATING TEMPERATURE		°C	0 to 55	

● Motor Dimension [mm] and Torque Characteristics

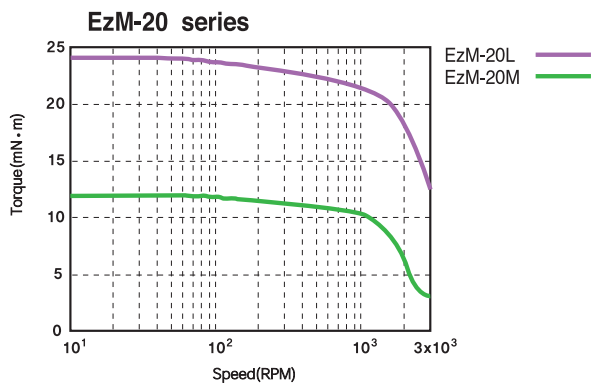
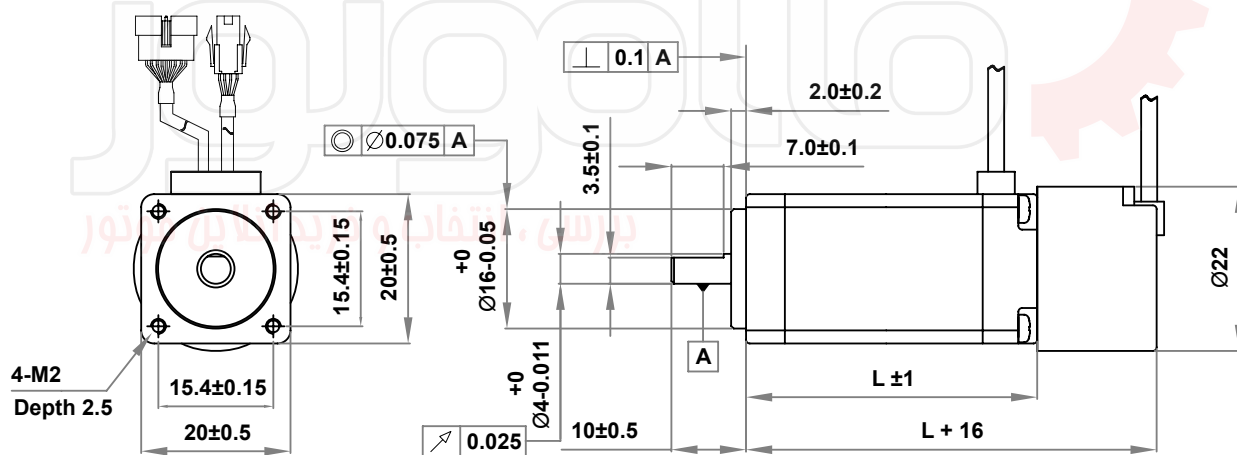

※ Measured Condition

Motor Voltage = 24VDC
 Motor Current = Rated Current(Refer to Motor Specification)
 Drive = Ezi-SERVO

● Motor Specifications

MODEL		UNIT	EzM-28S-D	EzM-28M-D	EzM-28L-D
DRIVE METHOD		----	BI-POLAR	BI-POLAR	BI-POLAR
NUMBER OF PHASES		----	2	2	2
VOLTAGE		VDC	3,04	3,04	3,42
CURRENT per PHASE		A	0,95	0,95	0,95
RESISTANCE per PHASE		Ohm	3,2	3,2	3,6
INDUCTANCE per PHASE		mH	2	5	5,8
HOLDING TORQUE		N · m	0,07	0,12	0,14
ROTOR INERTIA		g · cm ²	9	13	18
WEIGHTS		g	110	140	200
LENGTH (L)		mm	32	45	52
ALLOWABLE OVERHUNG LOAD (DISTANCE FROM END OF SHAFT)	3mm	N	30	30	30
	8mm		38	38	38
	13mm		53	53	53
	18mm		84	84	84
ALLOWABLE THRUST LOAD		N	Lower than motor weight		
INSULATION RESISTANCE		MOhm	100min. (at 500VDC)		
INSULATION CLASS		----	CLASS B (130°C)		
OPERATING TEMPERATURE		°C	0 to 55		

● Motor Dimension [mm] and Torque Characteristics

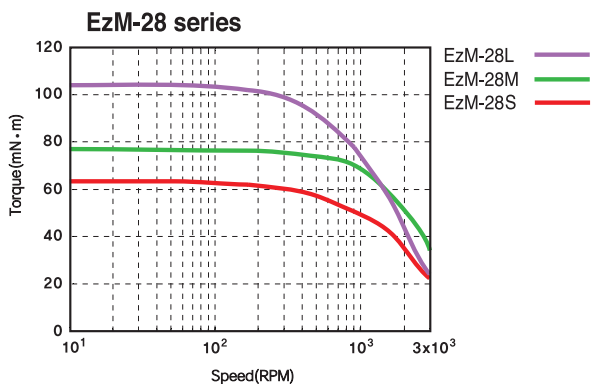
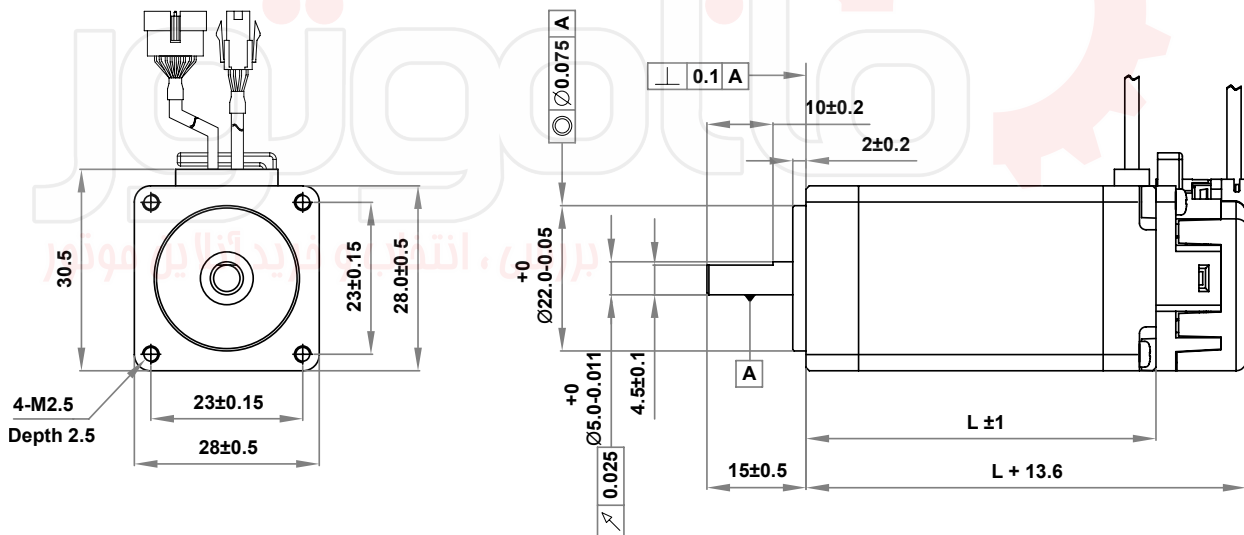

※ Measured Condition

Motor Voltage = 24VDC

Motor Current = Rated Current(Refer to Motor Specification)

Drive = Ezi-SERVO

● Motor Specifications

M O D E L	UNIT	EzM-42S-A	EzM-42M-A	EzM-42L-A	EzM-42XL-A	
		EzM-42S-B	EzM-42M-B	EzM-42L-B	EzM-42XL-B	
		EzM-42S-C	EzM-42M-C	EzM-42L-C	EzM-42XL-C	
DRIVE METHOD	----	BI-POLAR	BI-POLAR	BI-POLAR	BI-POLAR	
NUMBER OF PHASES	----	2	2	2	2	
VOLTAGE	VDC	3,36	4,32	4,56	7,2	
CURRENT per PHASE	A	1,2	1,2	1,2	1,2	
RESISTANCE per PHASE	Ohm	2,8	3,6	3,8	6	
INDUCTANCE per PHASE	mH	2,5	7,2	8	15,6	
HOLDING TORQUE	N · m	0,32	0,44	0,54	0,8	
ROTOR INERTIA	g · cm ²	35	54	77	114	
WEIGHTS	g	220	280	350	500	
LENGTH (L)	mm	33	39	47	59	
ALLOWABLE OVERHUNG LOAD (DISTANCE FROM END OF SHAFT)	3mm	N	22	22	22	22
	8mm		26	26	26	26
	13mm		33	33	33	33
	18mm		46	46	46	46
ALLOWABLE THRUST LOAD	N	Lower than motor weight				
INSULATION RESISTANCE	MOhm	100min. (at 500VDC)				
INSULATION CLASS	----	CLASS B (130°C)				
OPERATING TEMPERATURE	°C	0 to 55				

● Motor Dimension [mm] and Torque Characteristics

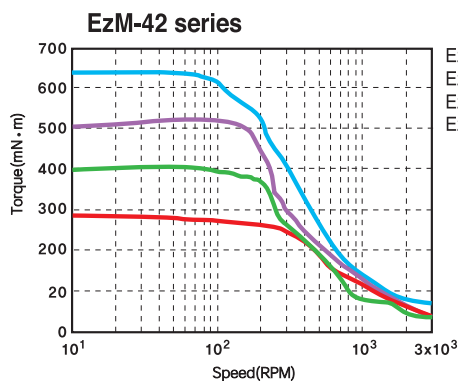
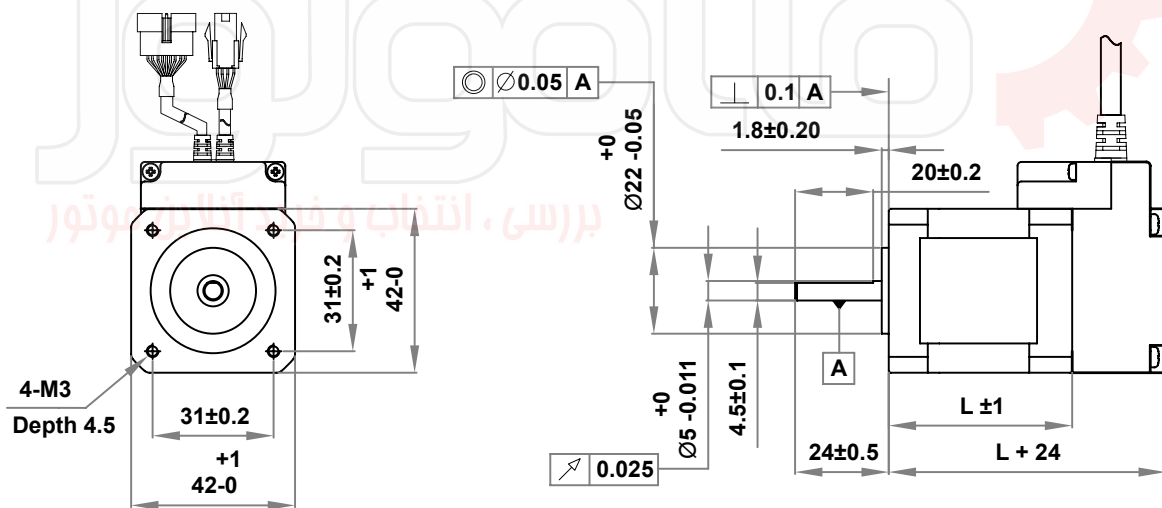

※ Measured Condition

Motor Voltage = 24VDC

Motor Current = Rated Current (Refer to Motor Specification)

Drive = Ezi-SERVO

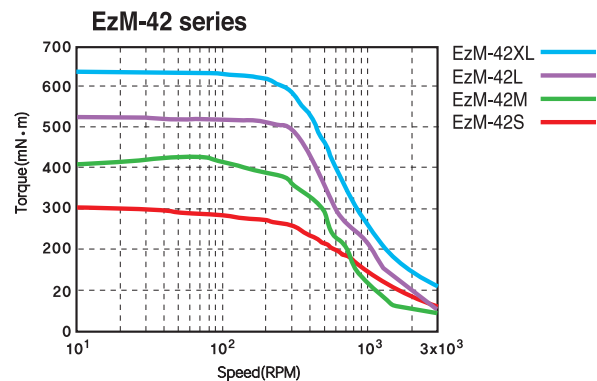

※ Measured Condition

Motor Voltage = 40VDC

Motor Current = Rated Current (Refer to Motor Specification)

Drive = Ezi-SERVO

● Motor Specifications

MODEL	UNIT	EzM-56S-A	EzM-56M-A	EzM-56L-A
		EzM-56S-B	EzM-56M-B	EzM-56L-B
		EzM-56S-C	EzM-56M-C	EzM-56L-C
DRIVE METHOD	----	BI-POLAR	BI-POLAR	BI-POLAR
NUMBER OF PHASES	----	2	2	2
VOLTAGE	VDC	1,56	2,1	2,7
CURRENT per PHASE	A	3	3	3
RESISTANCE per PHASE	Ohm	0,52	0,7	0,9
INDUCTANCE per PHASE	mH	1	2	3,8
HOLDING TORQUE	N · m	0,64	1	1,5
ROTOR INERTIA	g · cm ²	120	200	480
WEIGHTS	g	500	700	1150
LENGTH (L)	mm	46	54	80
ALLOWABLE OVERHUNG LOAD (DISTANCE FROM END OF SHAFT)	3mm	N	52	52
	8mm		65	65
	13mm		85	85
	18mm		123	123
ALLOWABLE THRUST LOAD	N	Lower than motor weight		
INSULATION RESISTANCE	MOhm	100min. (at 500VDC)		
INSULATION CLASS	----	CLASS B (130°C)		
OPERATING TEMPERATURE	°C	0 to 55		

● Motor Dimension [mm] and Torque Characteristics

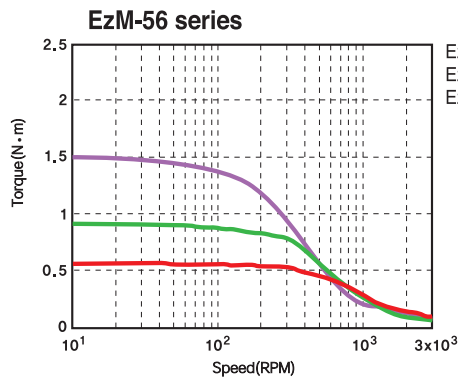
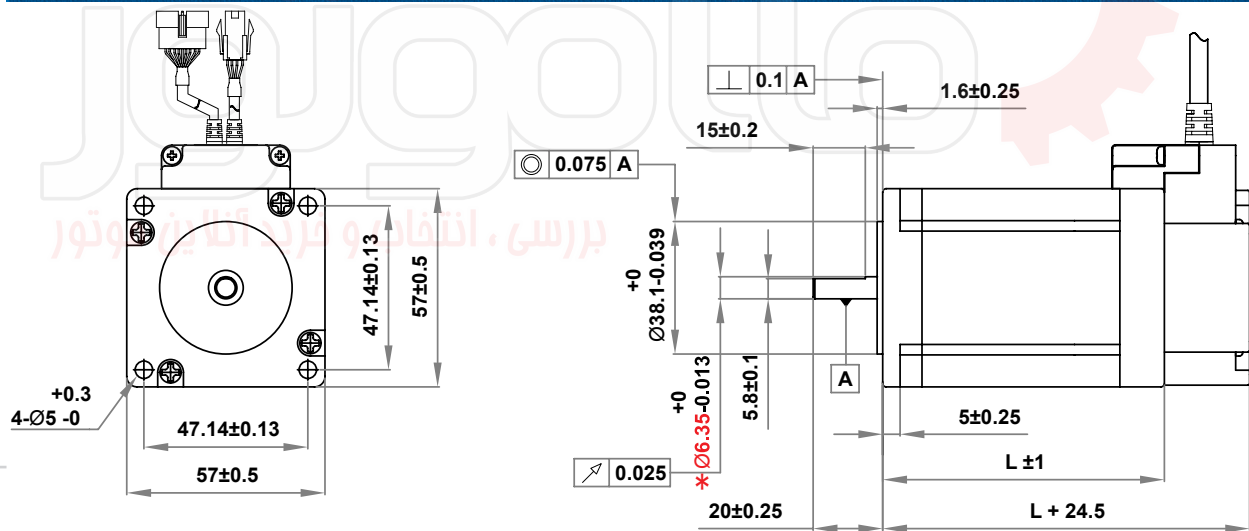

※ Measured Condition

Motor Voltage = 24VDC
 Motor Current = Rated Current(Refer to Motor Specification)
 Drive = Ezi-SERVO

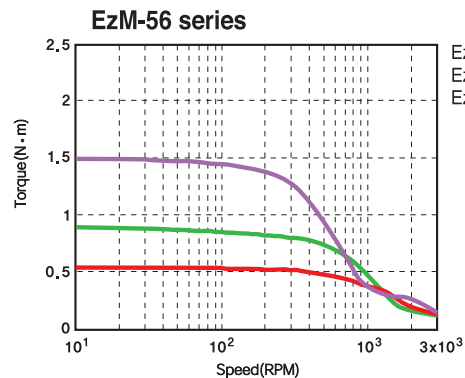

※ Measured Condition

Motor Voltage = 40VDC
 Motor Current = Rated Current(Refer to Motor Specification)
 Drive = Ezi-SERVO

* : There are 2 kinds size of front shaft diameter for EzM-56 series as $\phi 6.35$ and $\phi 8.0$.

● Motor Specifications

MODEL	UNIT	EzM-60S-A EzM-60S-B EzM-60S-C	EzM-60M-A EzM-60M-B EzM-60M-C	EzM-60L-A EzM-60L-B EzM-60L-C
DRIVE METHOD	----	BI-POLAR	BI-POLAR	BI-POLAR
NUMBER OF PHASES	----	2	2	2
VOLTAGE	VDC	1,52	1,56	2,6
CURRENT per PHASE	A	4	4	4
RESISTANCE per PHASE	Ohm	0,38	0,39	0,65
INDUCTANCE per PHASE	mH	064	1,2	2,4
HOLDING TORQUE	N · m	0,88	1,28	2,4
ROTOR INERTIA	g · cm ²	140	320	800
WEIGHTS	g	600	900	1600
LENGTH (L)	mm	46	56	90
ALLOWABLE OVERHUNG LOAD (DISTANCE FROM END OF SHAFT)	3mm	70	70	70
	8mm	87	87	87
	13mm	114	114	114
	18mm	165	165	165
ALLOWABLE THRUST LOAD	N	Lower than motor weight		
INSULATION RESISTANCE	MOhm	100min. (at 500VDC)		
INSULATION CLASS	----	CLASS B (130°C)		
OPERATING TEMPERATURE	°C	0 to 55		

● Motor Dimension [mm] and Torque Characteristics

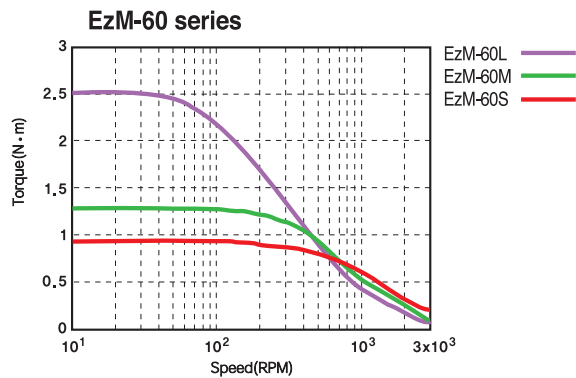
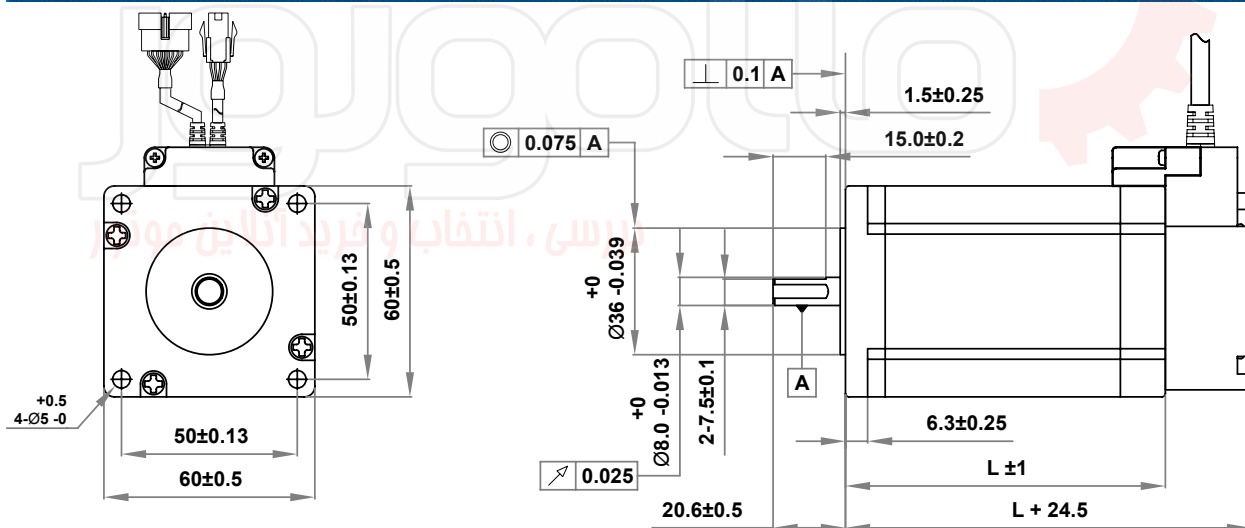

※ Measured Condition

Motor Voltage = 24VDC
 Motor Current = Rated Current(Refer to Motor Specification)
 Drive = Ezi-SERVO

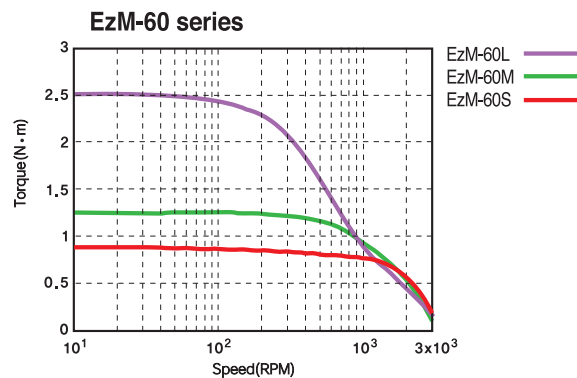

※ Measured Condition

Motor Voltage = 40VDC
 Motor Current = Rated Current(Refer to Motor Specification)
 Drive = Ezi-SERVO

● Motor Specifications

MODEL		UNIT	EzM-86M-A	EzM-86L-A	EzM-86XL-A
DRIVE METHOD		----	BI-POLAR	BI-POLAR	BI-POLAR
NUMBER OF PHASES		----	2	2	2
VOLTAGE		VDC	2.4	3.6	4.38
CURRENT per PHASE		A	6.0	6.0	6.0
RESISTANCE per PHASE		Ohm	0.4	0.6	0.73
INDUCTANCE per PHASE		mH	3.5	6.5	8.68
HOLDING TORQUE		N · m	4.5	8.5	12
ROTOR INERTIA		g · cm ²	1400	2700	4000
WEIGHTS		Kg	2.4	3.9	5.4
LENGTH (L)		mm	79	119	159
ALLOWABLE OVERHUNG LOAD (DISTANCE FROM END OF SHAFT)	3mm	N	270	270	270
	8mm		300	300	300
	13mm		350	350	350
	18mm		400	400	400
ALLOWABLE THRUST LOAD		N	Lower than motor weight		
INSULATION RESISTANCE		MOhm	100min. (at 500VDC)		
INSULATION CLASS		----	CLASS B (130°C)		
OPERATING TEMPERATURE		°C	0 to 55		

● Motor Dimension [mm] and Torque Characteristics

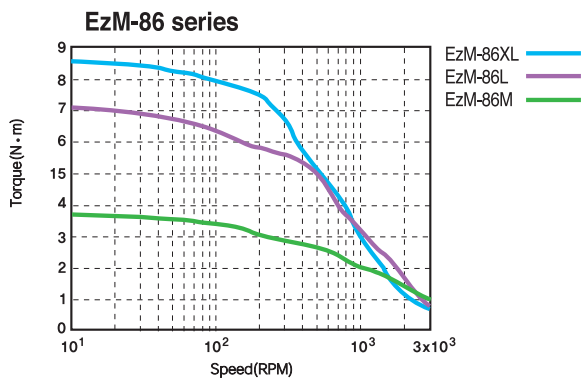
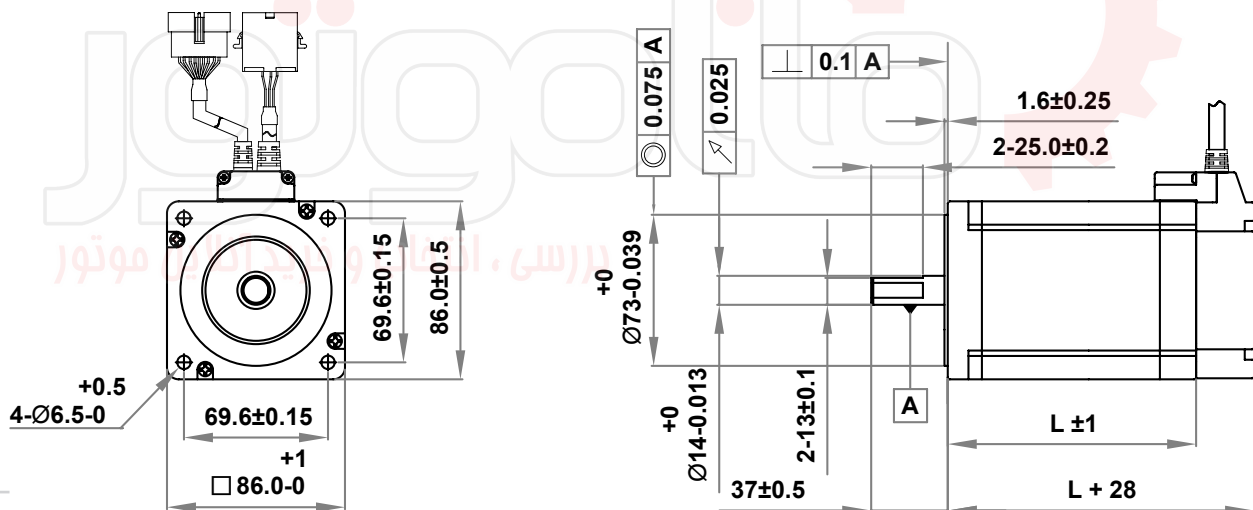

※ Measured Condition

Motor Voltage = 70VDC
 Motor Current = Rated Current (Refer to Motor Specification)
 Drive = Ezi-SERVO (EzS-PD-86 Series)

● Setting and Operating

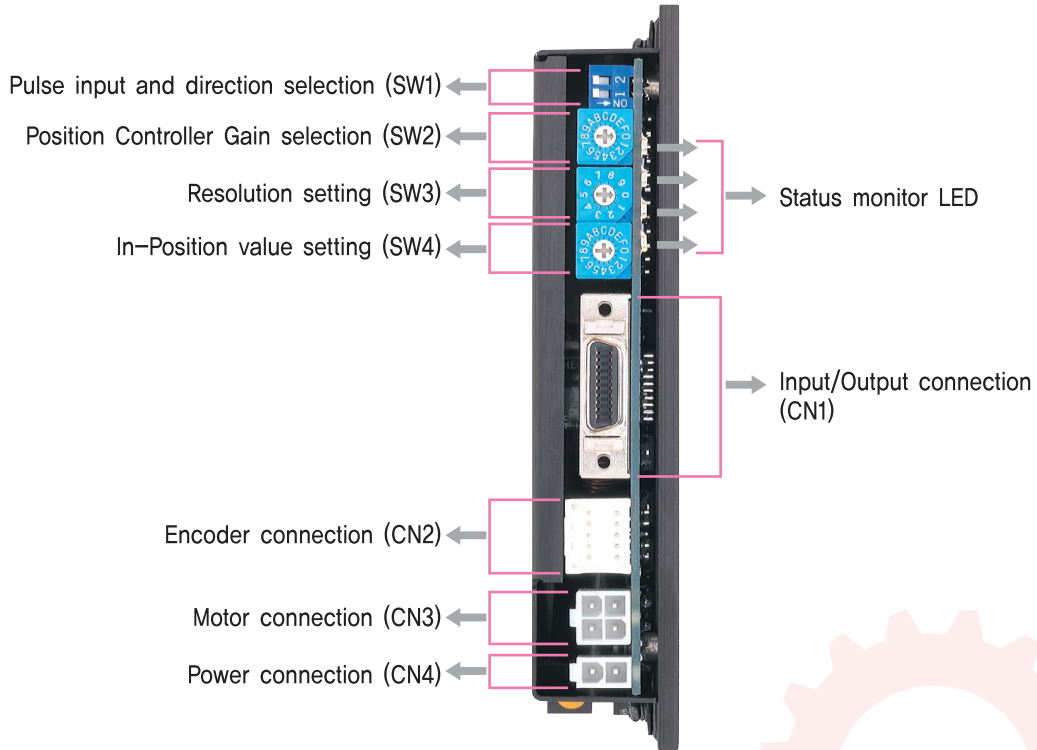

◆ 86mm motor drive only (EzS-PD-86 Series)

بررسی، انتخاب و خرید آنلاین موتور

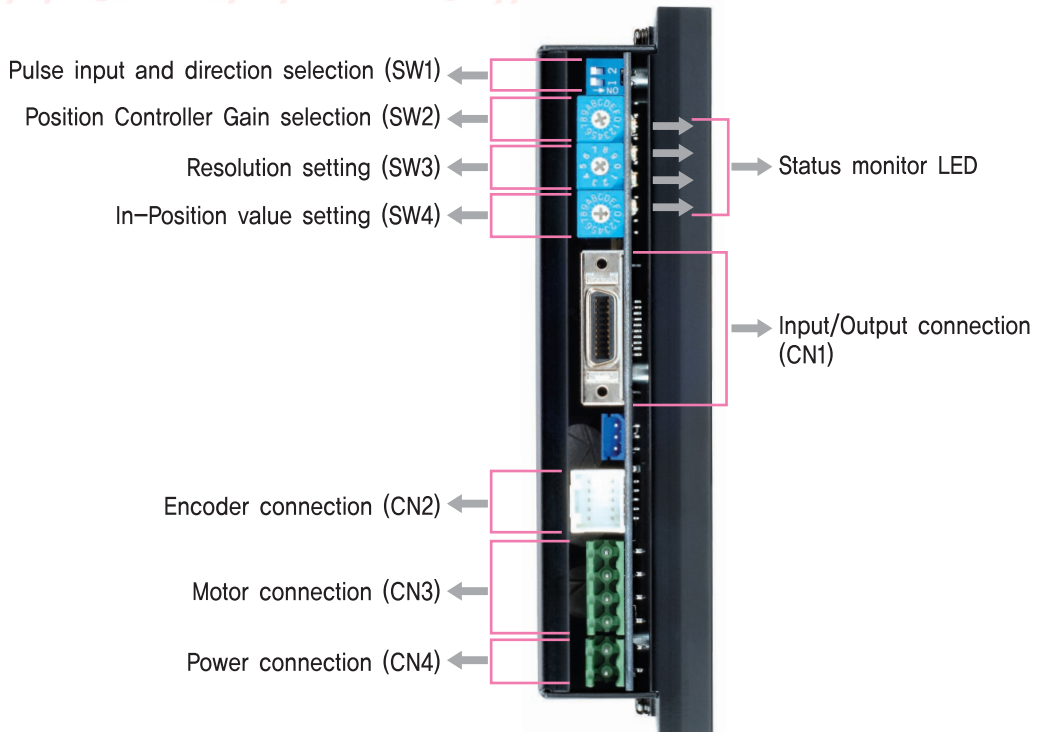

1. Status Monitor LED

Indication	Color	Function	ON/OFF Condition
PWR	Green	Power input indication	LED is turned ON when power is applied
INP	Yellow	Complete Positioning Motion	Lights On when Positioning error reaches within the preset pulse selected by rotary switch
SON	Orange	Servo On/Off Indication	Servo On : Lights On, Servo Off : Lights Off
ALM	Red	Alarm indication	Flash when protection function is activated (Identifiable which protection mode is activated by counting the blinking times)

◆ Protection functions and LED flash times

Times	Protection	Conditions
1	Over current	The current through power devices in inverter exceeds the limit value
2	Over speed	Motor speed exceed 3000rpm
3	Position tracking error	Position error value is higher than 90° in motor run state
4	Over load	The motor is continuously operated more than 5 second under a load exceeding the max. torque
5	Over temperature	Inside temperature of drive exceeds 55°C
6	Over regenerated voltage	Back-EMF more high limit value*1
7	Motor connect error	The power is ON without connection of the motor cable to drive
8	Encoder connect error	Cable connection error with Encoder connector in drive
9	Motor voltage error	Motor voltage is out of limited value*2
10	Inposition error	After operation is finished, a position error occurs
11	System error	Error occurs in drive system
12	ROM error	Error occurs in parameter storage device(ROM)
14	Input voltage error	Power source voltage is out of limited value*3
15	Position overflow error	Position error value is higher than 90° in motor stop state

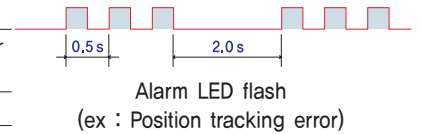

- *1 : Voltage limit of Back-EMF depends on motor model (Refer to the Manual)
- *2 : Motor limit voltage value depends on motor model (Refer to the Manual)
- *3 : Limit value provided to drives depends on driver model (Refer to the Manual)

2. Pulse input selection switch(SW1.1)

Indication	Switch Name	Functions
2P/1P	Selecting pulse input mode	Selectable 1-Pulse input mode or 2-Pulse input mode as Pulse input signal. ON : 1-Pulse mode OFF : 2-Pulse mode ※Default : 2-Pulse mode

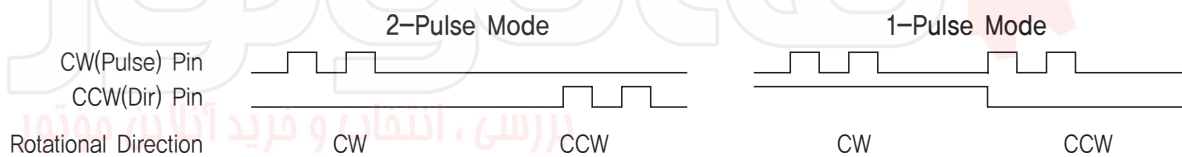

3. Rotational direction selection switch(SW1.2)

Indication	Switch Name	Functions
DIR	Switching Rotational Direction	Based on CW(+Dir signal) input to driver. ON : CCW(-Direction) OFF : CW(+Direction) ※Default : CW mode



4. Resolution selection switch(SW3)

The Number of pulse per revolution.

Position	Pulse/Rotation	Position	Pulse/Rotation
0	500*1	5	3600
1	500	6	5000
2	1000	7	6400
3	1600	8	7200
4	2000	9	10000*2

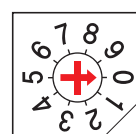

- *1 : Resolution value depend on encoder type.
- *2 : Default = 10,000

5. Position Controller Gain Selection switch(SW2)

The Position Controller Gain Switch allows for the correction of the motor position deviation after stopping caused by load and friction. Depending on the motor load, the user may have to select a different gain position to stabilize and to correct positional error quickly.

To tune the controller

1. Set the switch to "0" position.
2. Start to rotate the switch until system becomes stable.
3. Rotate the switch +/- 1~2 position to reach better performance.

Position	Time Constant of the Integral part	Proportional Gain*1
0	1	1
1	1	2
2	1	3
*23	1	4
4	1	5
5	1	6
6	2	1
7	2	2
8	2	3
9	2	4
A	2	5
B	3	1
C	3	2
D	3	3
E	3	4
F	3	5

*1 : Value in the columns are in relative units. They only show the parameter changes depending on the switch's position.

*2 : Default = 3

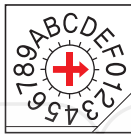

6. In-Position Value Setting switch(SW4)

To select the output condition of In-position signal, In-position output signal is generated when the pulse number of positional error is lower than selected In-position value set by this switch after positioning command is executed.

Position	In-Position Value[Pulse] Fast Response	Position	In-Position Value[Pulse] Accurate Response
*10	0	8	0
1	1	9	1
2	2	A	2
3	3	B	3
4	4	C	4
5	5	D	5
6	6	E	6
7	7	F	7

*1 : Default = 0

※Please refer to User Manual for setup.



7. Motor Connector(CN3)

NO.	Function
1	A Phase
2	B Phase
3	/A Phase
4	/B Phase



NO.	Function
1	/B Phase
2	B Phase
3	/A Phase
4	A Phase

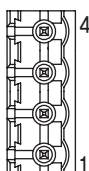

※Only for 86mm motor drive.

8. Power Connector(CN4)

NO.	Function
1	24VDC ±10%
2	GND



NO.	Function
1	GND
2	40~70VDC

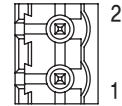

※Only for 86mm motor drive.

9. Encoder connector(CN2)

NO.	Function	I/O
1	A+	Input
2	A-	Input
3	B+	Input
4	B-	Input
5	Z+	Input
6	Z-	Input
7	5VDC	Output
8	5VDC GND	Output
9	Frame GND	----
10	Frame GND	----

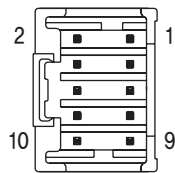

10. Input/Output signal(CN1)

NO.	Function	I/O
1	CW+(Pulse+)	Input
2	CW-(Pulse-)	Input
3	CCW+(Dir+)	Input
4	CCW-(Dir-)	Input
5	A+	Output
6	A-	Output
7	B+	Output
8	B-	Output
9	Z+	Output
10	Z-	Output
11	Alarm	Output
12	In-Position	Output
13	Servo On/Off	Input
14	Alarm Reset	Input
15	NC	----
16	BRAKE+	Output
17	BRAKE-	Output
18	S-GND	Output
19	24VDC GND	Input
20	24VDC	Input

※BRAKE function is optional

※There is no BRAKE function for 86mm motor drive.

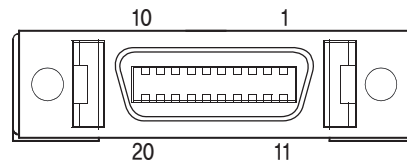

System Configuration

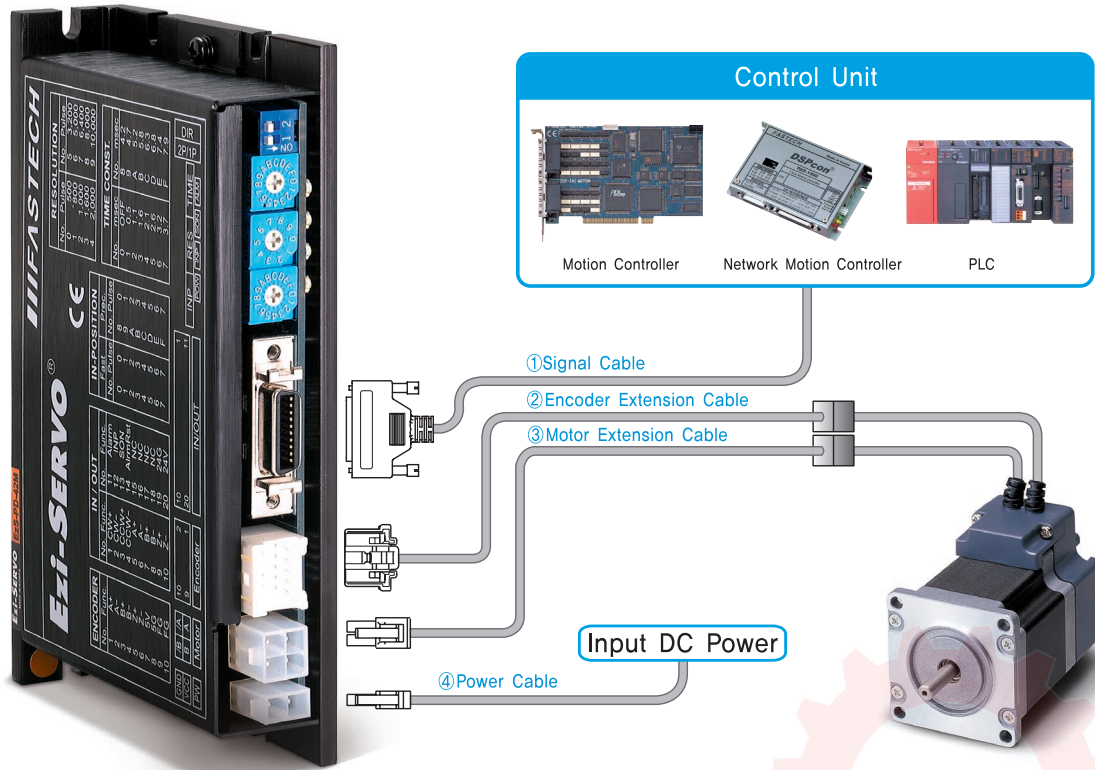

Type	Power Cable	Motor Cable	Encoder Cable	Signal Cable
Standard Length	-	30cm	30cm	-
Max. Length	2m	20m	20m	20m

بررسی، انتخاب و خرید آنلاین موتور

1. Cable Option

①Signal Cable

Available to connect between Control System and Ezi-SERVO.

Item	Length[m]	Remark
CSVO-S-□□□F	□□□	Normal Cable
CSVO-S-□□□M	□□□	Robot Cable

□ is for Cable Length. The unit is 1m and Max, 20m length.

②Encoder Extension Cable

Available to extended connection between Encoder and Ezi-SERVO.

Item	Length[m]	Remark
CSVO-E-□□□F	□□□	Normal Cable
CSVO-E-□□□M	□□□	Robot Cable

□ is for Cable Length. The unit is 1m and Max, 20m length.

③Motor Extension Cable

Available to extended connection between motor and Ezi-SERVO.

Item	Length[m]	Remark
CSVO-M-□□□F	□□□	Normal Cable
CSVO-M-□□□M	□□□	Robot Cable

□ is for Cable Length. The unit is 1m and Max, 20m length.

④Power Cable

Available to connect between Power and Ezi-SERVO.

Item	Length[m]	Remark
CSVO-P-□□□F	□□□	Normal Cable
CSVO-P-□□□M	□□□	Robot Cable

□ is for Cable Length. The unit is 1m and Max, 2m length.

● System Configuration [Only for 86mm motor drive (EzS-PD-86 series)]

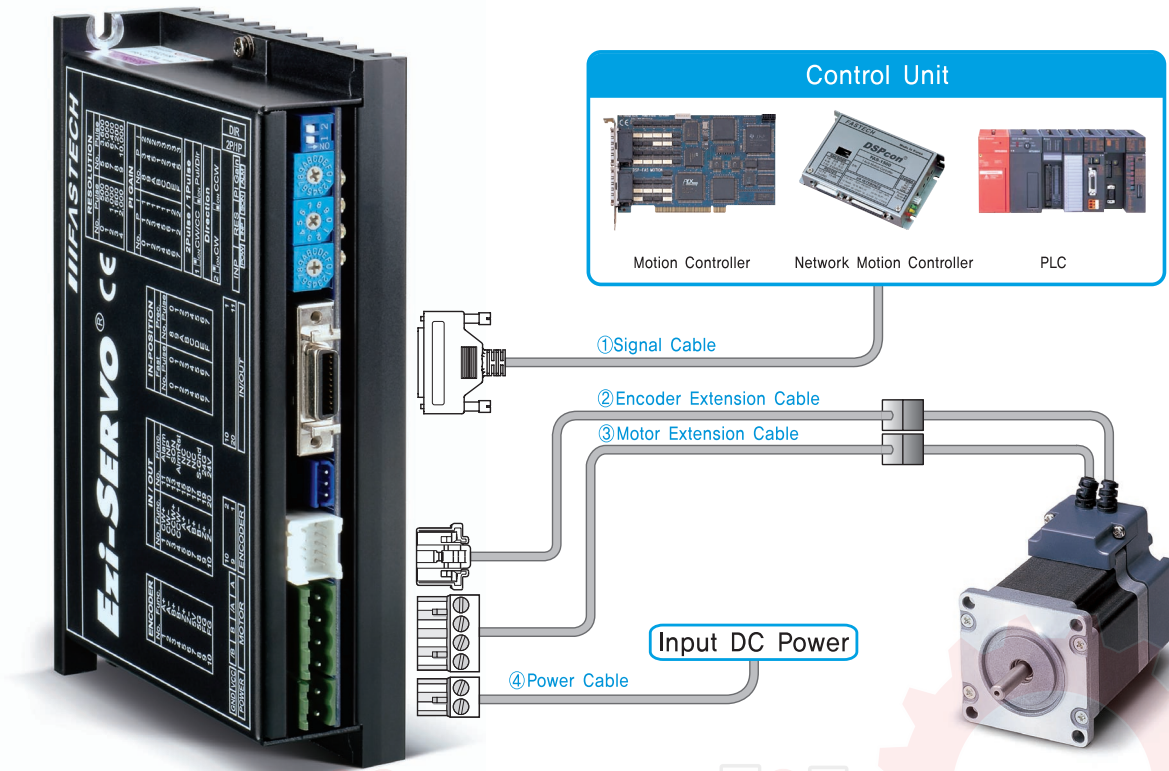

Type	Power Cable	Motor Cable	Encoder Cable	Signal Cable
Standard Length	-	30cm	30cm	-
Max. Length	2m	20m	20m	20m

بررسی، انتخاب و خرید آنلاین موتور

1. Cable Option

①Signal Cable

Available to connect between Control System and Ezi-SERVO.

Item	Length[m]	Remark
CSVO-S-□□□F	□□□	Normal Cable
CSVO-S-□□□M	□□□	Robot Cable

□ is for Cable Length. The unit is 1m and Max. 20m length.

②Encoder Extension Cable

Available to extended connection between Encoder and Ezi-SERVO.

Item	Length[m]	Remark
CSVO-E-□□□F	□□□	Normal Cable
CSVO-E-□□□M	□□□	Robot Cable

□ is for Cable Length. The unit is 1m and Max. 20m length.

③Motor Extension Cable

Available to extended connection between motor and Ezi-SERVO.

Item	Length[m]	Remark
CSVP-M-□□□F	□□□	Normal Cable
CSVP-M-□□□M	□□□	Robot Cable

□ is for Cable Length. The unit is 1m and Max. 20m length.

④Power Cable

Available to connect between Power and Ezi-SERVO.

Item	Length[m]	Remark
CSVP-P-□□□F	□□□	Normal Cable
CSVP-P-□□□M	□□□	Robot Cable

□ is for Cable Length. The unit is 1m and Max. 2m length.

External Wiring Diagram

FASTECH Ezi-SERVO

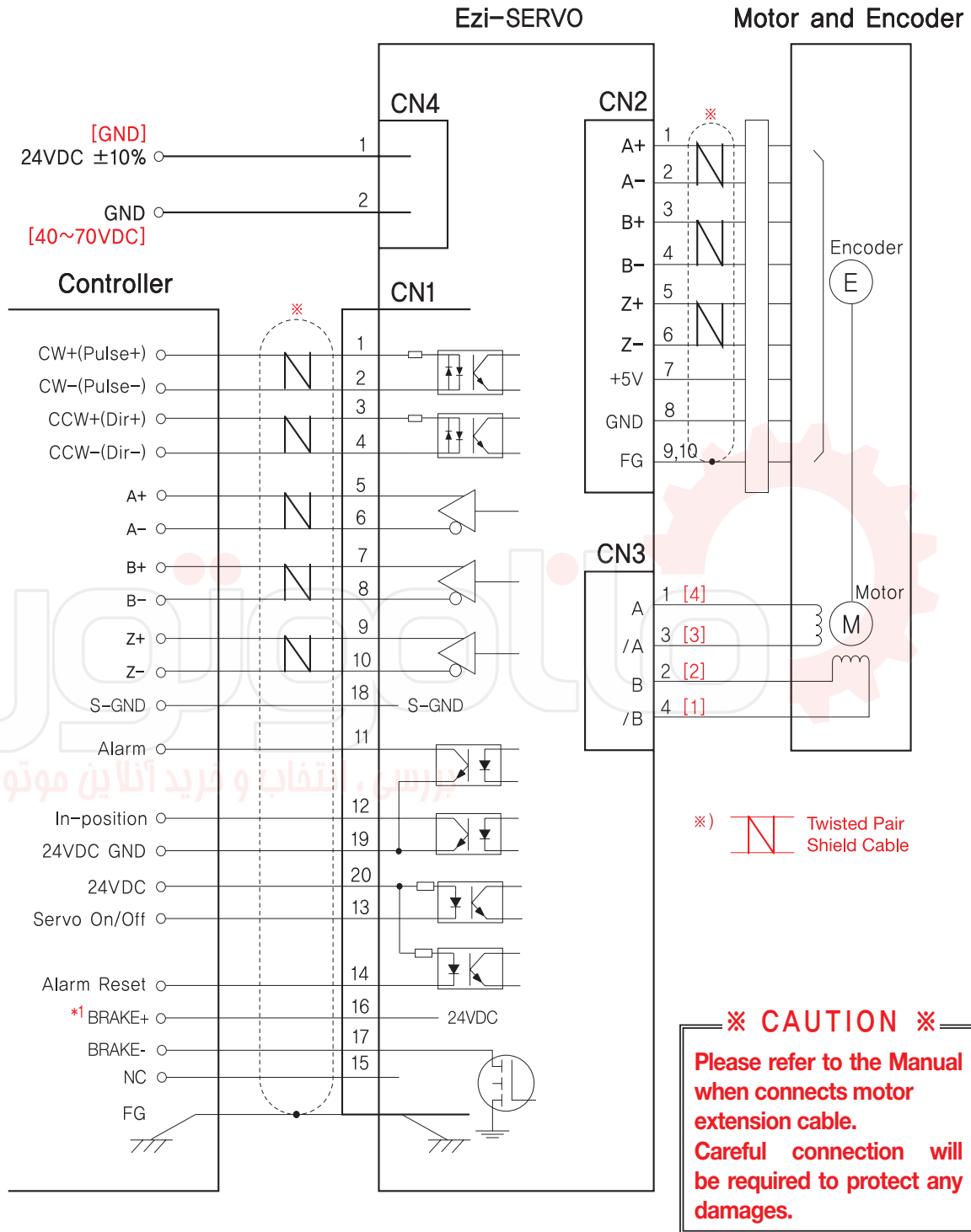

* Red color is only 86mm motor drive,(EzS-PD-86 series) Pay attention to red color that describe the difference.

*1 : There is no BRAKE function for 86mm motor drive.

Control Signal input/output Description

1 Input signal

Input signals of the drive are all photocoupler protected. The signal shows the status of internal photocouplers [ON: conduction], [OFF: Non-conduction], not displaying the voltage levels of the signal.

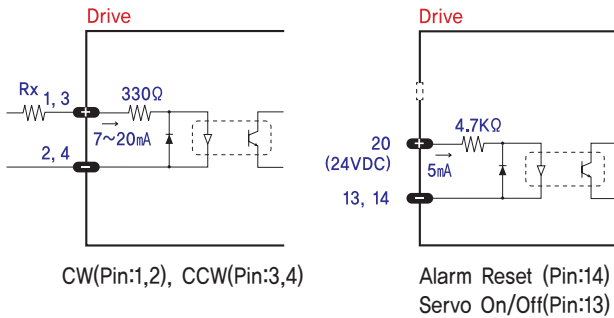

◆ CW, CCW Input

This signal can be used to receive a positioning pulse command from a user host motion controller. The user can select 1-pulse input mode or 2-pulse input mode (refer to switch No.1, SW1). The input schematic of CW, CCW is designed for 5V TTL level. When using 5V level as an input signal, the resistor Rx is not used and connect to the driver directly. When the level of input signal is more than 5V, Rx resistor is required. If the resistor is absent, the drive will be damaged! If the input signal level is 12V, Rx value is 2.2Kohm and 24V, Rx value is 4.7Kohm.

◆ Servo On/Off Input

This input can be used only to adjust the position by manually moving the motor shaft from the load-side. By setting the signal [ON], the driver cuts off the power supply to the motor. Then, one can manually adjust output position. When setting the signal back to [OFF], the driver resumes the power to the motor and recovers the holding torque. When driving a motor, one needs to set the signal [OFF].

◆ Alarm Reset Input

When a protection mode has been activated, a signal to this alarm reset input cancels the Alarm output.

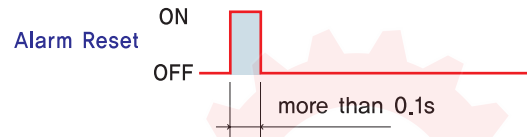

※ By setting the alarm reset input signal [ON], cancel the Alarm output. Before cancel the Alarm output, have to remove the source of alarm.

2 Output signals

Output signals from the driver are photocoupler protected: Alarm, In-Position and the Line Driver Outputs (encoder signal). In the case of photocoupler outputs, the signal indicates the status of internal photocouplers [ON: conduction], [OFF: Non-conduction], not displaying the voltage levels of the signal.

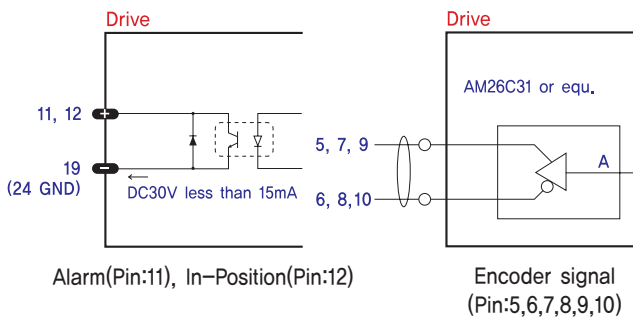

◆ Alarm Output

The Alarm output indicates [ON] when the driver is in a normal operation. If a protection mode has been activated, it goes [OFF]. A host controller needs to detect this signal and stop sending a motor driving command. When the driver detects an abnormal operation such as overload or over current of the motor, it sets the Alarm output to [OFF], flashes the Alarm LED, disconnect the power to a motor and stops the motor simultaneously.

[Caution] Only at the Alarm output port, the photocoupler isolation is in reverse. When the driver is in normal operation the Alarm output is [ON]. On the contrary when the driver is in abnormal operation that start protection mode, the Alarm output is [OFF].

◆ In-Position Output

In-Position signal is [ON] when positioning is completed. This signal is [ON] when the motor position error is within the value set by the switch SW4.

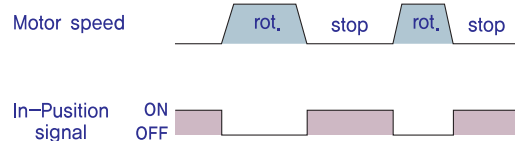

◆ Encoder signal Output

The encoder signal is a line driver output. This can be used to confirm the stop position.



FASTECH Co., Ltd.

Rm #1202, Bucheon Technopark 401 Dong, Yakdae-dong,
Wonmi-Gu, Bucheon-si, Gyeonggi-do, Rep. Of Korea (Zip:420-734)
TEL : 82-32-234-6300, 6301 FAX : 82-32-234-6302
Email : fastech@fastech.co.kr Homepage : www.fastech.co.kr

FASTECH USA

2585 Mariners Way SE
Southport, NC 28461 USA
TEL : 910,795,2380 Email : fastech@fastech.co.kr
Homepage : www.fastech-us.com