

Stepping Motors

2-Phase Stepping Motors

ماہاموینور

پرزسی، انتخاب و خرید آنلاین موتور

Page

2-Phase **PK/PV** Series Without Encoder C-218
 2-Phase **PK** Series With Encoder C-261

Introduction

QSTEP
AS
AC Input

QSTEP
ASC
DC Input

5-Phase
Microstep
RK
AC Input

2-Phase
Full/Half
UMK

5-Phase
Microstep
CRK

2-Phase
Microstep
RBK
DC Input

2-Phase
Microstep
CMK

2-Phase **PK/PV** Series
Without Encoder

2-Phase **PK** Series
With Encoder

2-Phase
PK/PV
Without Encoder

2-Phase
PK
With Encoder

EMP400
5G8030J
Controllers

Accessories

Installation

RoHS RoHS-Compliant

2-Phase Stepping Motors

● Additional Information ●
 Technical reference → Page F-1
 Safety standards → Page G-2

Seven frame sizes are available in a range from 28 mm (1.10 in.) to 85 mm (3.35 in.). In addition to the standard type, we offer a high-torque type, **PV** Series (high inertia capability), a high-resolution type and the **SH** geared type. The motor windings also come in various specifications.







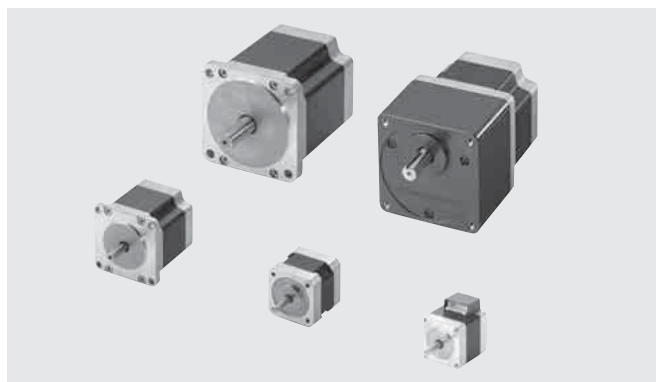









■ RoHS RoHS-Compliant

The 2-phase **PK/PV** Series conform to the RoHS Directive that prohibits the use of six chemical substances including lead and cadmium.

● Details of RoHS Directive → Page G-38



■ Wide Range of Motor Variations

Series/Type	Motor Frame Size						
	28 mm (1.10 in.)	35 mm (1.38 in.)	42 mm (1.65 in.)	50 mm (1.97 in.)	56.4 mm (2.22 in.)*1	60 mm (2.36 in.)	85 mm (3.35 in.)*2
High-Torque Type	 Page C-218	 Page C-222	 Page C-224	-	-	-	-
Standard Type	-	-	 Page C-226	 Page C-236	 Page C-238 With Encoder → Page C-261	-	 Page C-253
PK Series Standard Type Terminal Box	-	-	-	-	 Page C-242	-	 Page C-257
High-Resolution Type	-	-	 Page C-230	-	 Page C-244 With Encoder → Page C-264	-	-
SH Geared Type	 Page C-220	-	 Page C-234	-	 Page C-248 *1	-	 Page C-259 *2
PV Series (High inertia capability)	-	-	-	-	-	 Page C-250	-

*1 Gearhead frame size is 60 mm (2.36 in.).

*2 Gearhead frame size is 90 mm (3.54 in.).

System Configuration

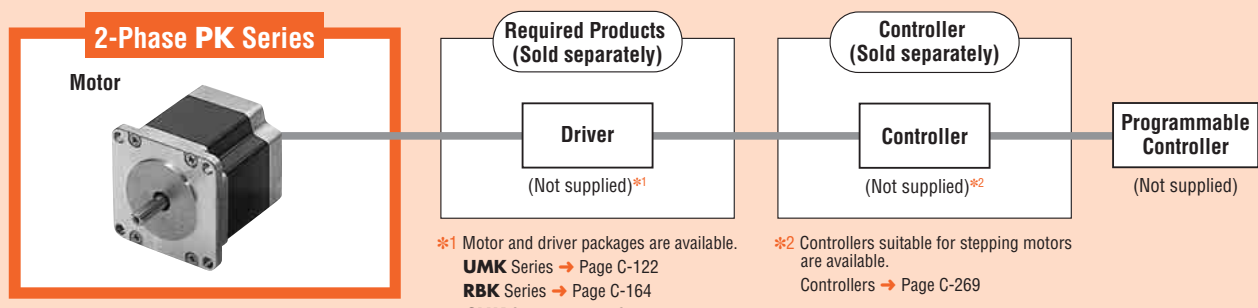

Accessories and Peripheral Equipment (Sold separately)



① **Motor Mounting Brackets**
(→ Page C-312)



② **Flexible Couplings**
(→ Page C-302)



③ **Clean Dampers**
(→ Page C-310)



④ **Motor Lead Wire/Connector Assembly**
(→ Page C-299)

No.	Product Name	Overview	Page
①	Motor Mounting Brackets	Dedicated mounting bracket for the motor.	C-312
②	Flexible Couplings	Coupling that connects the motor shaft to the driven shaft.	C-302
③	Clean Dampers	Dedicated damper for suppressing stepping motor vibration.	C-310
④	Motor Lead Wire/Connector Assembly	Lead wire with a connector crimped for connector-coupled motors [0.6 m, 1 m (2 ft., 3.3 ft.)].	C-299

Example of System Configuration



The system configuration shown above is an example. Other combinations are available.

2-Phase Stepping Motor and Driver Packages

To achieve maximum performance, motors with dedicated drivers are also available.

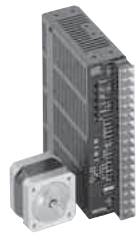

AC Input
UMK Series
→ Page C-122

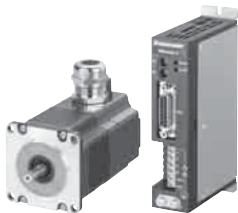

DC Input
Microstep Drive
RBK Series
→ Page C-164

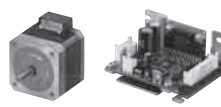

DC Input
Microstep Drive
CMK Series
→ Page C-180

- Introduction
- AC Input **QSTEP AS**
- DC Input **QSTEP ASG**
- 5-Phase Microstep **RK** AC Input
- 2-Phase Full/Half **UMK**
- 5-Phase Microstep **CMK**
- 2-Phase Microstep **RBK** DC Input
- 2-Phase Microstep **CMK** DC Input
- 2-Phase PK/PV Without Encoder
- 2-Phase PK With Encoder
- EMP400** Controllers
- SG8030J**
- Accessories
- Installation

Features

PK Series

High-Torque Type

This motor type combines high torque and a compact size. Three frame sizes, 28 mm (1.10 in.), 35 mm (1.38 in.) and 42 mm (1.65 in.), are available. Each specification provides torque equivalent to a motor of the next larger frame size, supporting high torque operation even in the high speed range.

For example, high-torque type **PK246PB** [motor frame size 42 mm (1.65 in.)] has the same holding torque as the standard type **PK266-01B** [motor frame size 56.4 mm (2.22 in.)]. This means a smaller size motor will maintain the same torque. This allows for downsized and lightweight equipment.

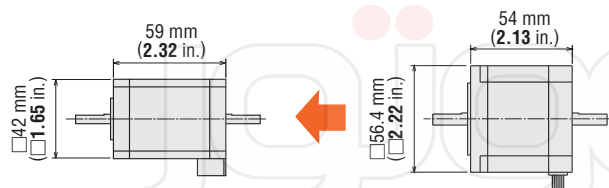
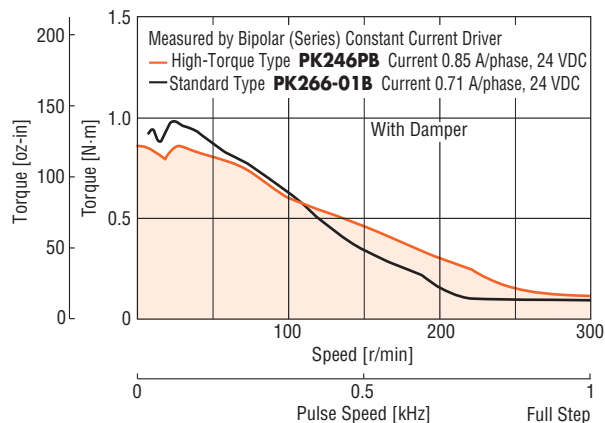

High-Torque Type	Type	Standard Type
PK246PB	Model	PK266-01B
0.93 N·m (132 oz-in)	Holding Torque	1.17 N·m (166 oz-in)
$114 \times 10^{-7} \text{ kg}\cdot\text{m}^2$ (0.77 oz-in ²)	Rotor Inertia	$300 \times 10^{-7} \text{ kg}\cdot\text{m}^2$ (1.64 oz-in ²)

Standard Type

The standard **PK Series** 2-phase stepping motor offers balanced performance enhanced by high torque, low vibration and low noise. The optimal motor size and winding specification can be selected from a wide range of motor variations.

With Encoder

The **PK Series** 2-phase stepping motor with encoder offers high torque and precise feedback capability.

- Encoder feedback type: Incremental
- Two feedback resolutions: 200 and 400 pulses/revolution
- Provides closed loop system capability

Terminal Box Type

The motor conforms to the IP65 standard of ingress protection against dust and water.

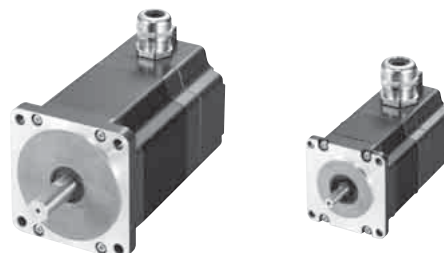

• Terminal-Block Connection Design

The motor can be wired directly from its terminal block.

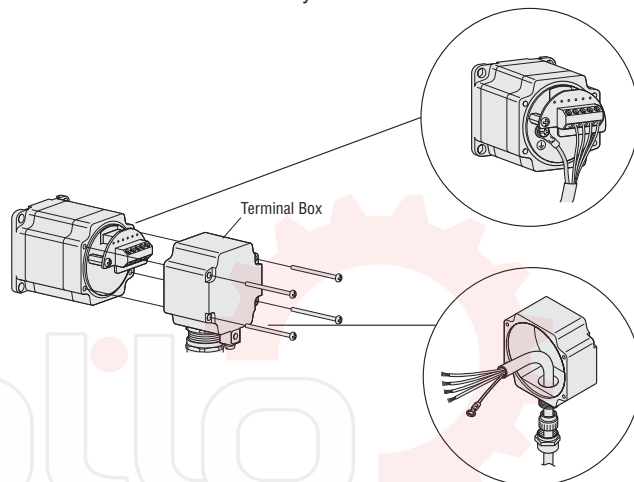

High-Resolution Type

These 2-phase, high resolution stepping motors have half the step angle of standard stepping motors. The high-resolution type increases motor resolution from 200 steps/revolution to 400 steps/revolution. Smaller step angles can be achieved by half-step driving or microstep driving. Such options, however, do not improve accuracy. Other than having twice as many rotor teeth as standard stepping motors, all other structures are exactly the same as the standard motors.

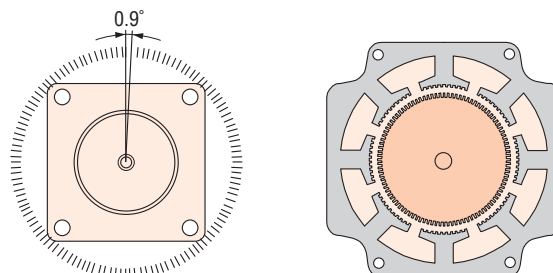

PV Series

High Inertia Capability

The **PV** Series provides, on average, 1.5 times higher torque than a standard stepping motor. By utilizing a larger rotor diameter, larger magnets can be used to significantly increase the output torque.

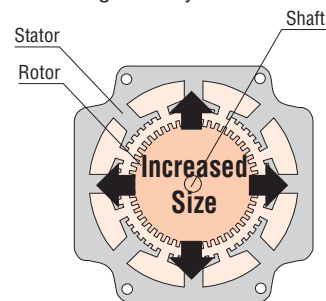

Motor structure
(Cross section perpendicular to shaft)

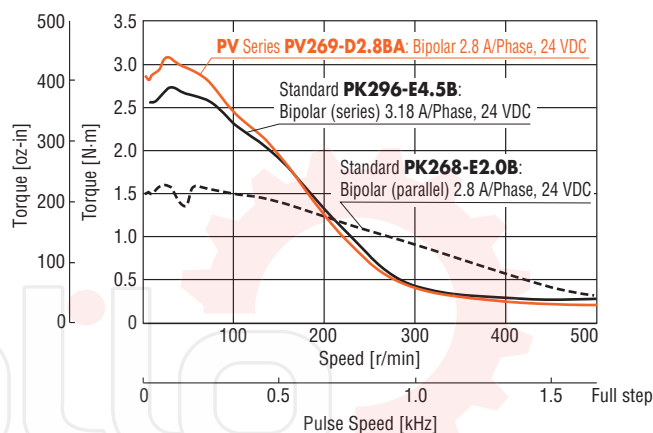

Comparison of Angle – Torque Characteristics

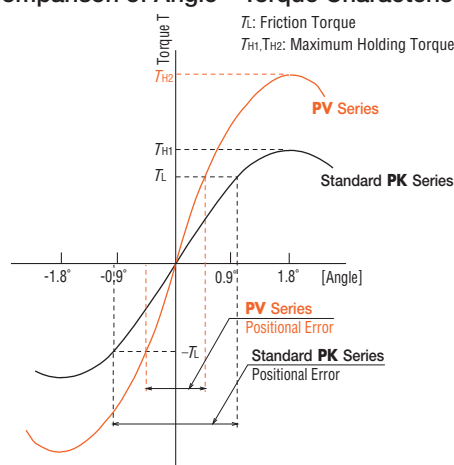

All equipment has a friction load, and the motor stops when the motor output torque and friction load torque are balanced. As shown in the characteristics above, the larger the output torque per step angle, the less the motor is influenced by the friction load, so positioning accuracy is improved. Stop positioning displacement by external force does not occur as often.

(1) High-Resolution Type (0.9°/step)

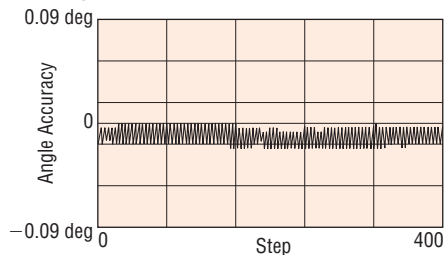

(2) Standard Type (1.8°/step)

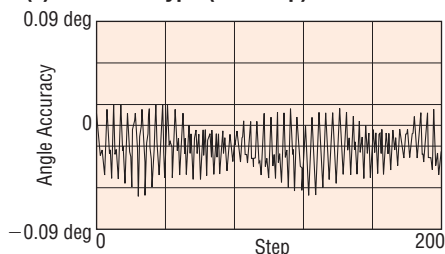

(3) Standard Type (0.9°/step)

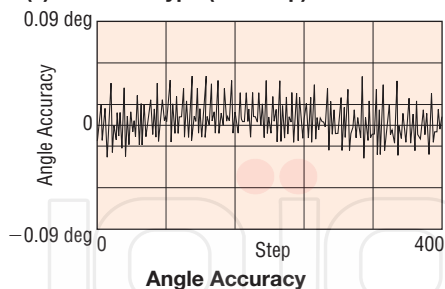

SH Geared Type

Incorporating **SH** gears with high permissible torque, these models offer the full benefit of the speed reducing capability of geared motors, delivering high resolution, high torque and smooth low-speed rotation. With performance like this, the **SH** geared type can easily satisfy the requirements of various kinds of low-speed positioning applications.

● Smooth Rotation at Low Speeds

Stepping motors at low speed produce a relatively high amount of vibration. Use of a gearhead allows for an increase in the speed of the motor which results in a smoother motion while maintaining the low output speed required by the application.

● Six Gear Ratios

SH geared motors are available with six different gear ratios: 3.6:1, 7.2:1, 9:1, 10:1, 18:1, 36:1. The low ratios of these gearheads can greatly facilitate speed control of the 2-phase stepping motors.

● **PK223-SG** type is not available in a gear ratio of 3.6:1.

● Ideal for High Inertia Drive

The stepping motor itself can drive an inertia of 10 times the rotor inertia. The geared type can reduce the load inertia by the square of the gear ratio. Therefore, the geared type is suitable for driving larger inertial loads.

Product Number Code

PK Series

High-Torque Type

PK 2 3 3 P A

① ② ③ ④ ⑤ ⑥

①	Series	PK: PK Series
②	2: 2-Phase	
③	Motor Frame Size	2: 28 mm (1.10 in.) 3: 35 mm (1.38 in.) 4: 42 mm (1.65 in.)
④	Motor Case Length	
⑤	Motor Type	P: High-Torque Type
⑥	Shaft Type	A: Single Shaft B: Double Shaft

Standard Type, High-Resolution Type

PK 2 4 3 M - 0 1 B A

① ② ③ ④ ⑤ ⑥ ⑦ ⑧ ⑨

①	Series	PK: PK Series
②	2: 2-Phase	
③	Motor Frame Size	4: 42 mm (1.65 in.) 5: 50 mm (1.97 in.) 6: 56.4 mm (2.22 in.) 9: 85 mm (3.35 in.)
④	Motor Case Length	
⑤	Motor Type	Blank: Standard Type (1.8°/step) M: High-Resolution Type (0.9°/step)
⑥	Motor Lead	0: 6 Leads E, F: 8 Leads
⑦	Winding Specification	
⑧	Shaft Type	A: Single Shaft B: Double Shaft
⑨	U.S.A. Version	

SH Geared Type

• Motor Frame Size 28 mm (1.10 in.)

PK 2 2 3 P A - SG 10

① ② ③ ④ ⑤ ⑥ ⑦ ⑧

①	Series	PK: PK Series
②	2: 2-Phase	
③	Motor Frame Size	2: 28 mm (1.10 in.)
④	Motor Case Length	
⑤	Motor Type	
⑥	Shaft Type	A: Single Shaft B: Double Shaft
⑦	Gearhead Type	SG: SH Geared Type
⑧	Gear Ratio	

PV Series (High inertia capability)

PV 2 6 6 - 0 2 B A

① ② ③ ④ ⑤ ⑥ ⑦ ⑧

①	Series	PV: PV Series
②	2: 2-Phase	
③	Motor Frame Size	6: 60 mm (2.36 in.)
④	Motor Case Length	
⑤	Motor Lead	0: 6 Leads D: 4 Leads
⑥	Winding Specification	
⑦	Shaft Type	A: Single Shaft B: Double Shaft
⑧	U.S.A. Version	

Standard Type Terminal Box

PK 2 6 4 D A T

① ② ③ ④ ⑤ ⑥ ⑦

①	Series	PK: PK Series
②	2: 2-Phase	
③	Motor Frame Size	6: 56.4 mm (2.22 in.) 9: 85 mm (3.35 in.)
④	Motor Case Length	
⑤	Motor Lead	D: 4 Leads E: 8 Leads
⑥	Shaft Type	A: Single Shaft
⑦	Terminal Box	

Standard Type, High-Resolution Type with Encoder

PK 2 6 6 M - 0 1 A R11

① ② ③ ④ ⑤ ⑥ ⑦ ⑧ ⑨

①	Series	PK: PK Series
②	2: 2-Phase	
③	Motor Frame Size	6: 56.4 mm (2.22 in.)
④	Motor Case Length	
⑤	Motor Type	Blank: Standard Type (1.8°/step) M: High-Resolution Type (0.9°/step)
⑥	Motor Lead	0: 6 Leads E: 8 Leads
⑦	Winding Specification	
⑧	Shaft Type	A: Single Shaft
⑨	Encoder Resolution	R11: 200 P/R R12: 400 P/R

• Motor Frame Size 42 mm (1.65 in.), 60 mm (2.36 in.), 90 mm (3.54 in.)

PK 2 6 4 A 1 A - SG 10

① ② ③ ④ ⑤ ⑥ ⑦ ⑧ ⑨

①	Series	PK: PK Series
②	2: 2-Phase	
③	Motor Frame Size	4: 42 mm (1.65 in.) 6: 60 mm (2.36 in.) 9: 90 mm (3.54 in.)
④	Motor Case Length	
⑤	Shaft Type	A: Single Shaft B: Double Shaft
⑥	Winding Specification	
⑦	U.S.A. Version	
⑧	Gearhead Type	SG: SH Geared Type
⑨	Gear Ratio	

Wirings and Connections

PK Series High-Torque Type, Standard Type, High-Resolution Type, SH Geared Type and PV Series

Motor Wirings

4 Lead Motor

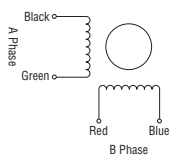

6 Lead Motor

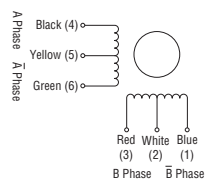

8 Lead Motor

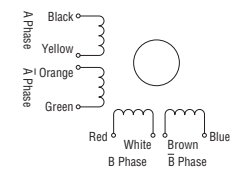

Wiring Connection Diagrams

4 Leads Bipolar Connection

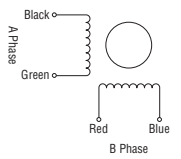

6 Leads Unipolar Connection

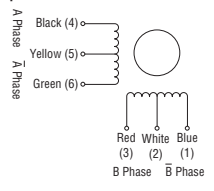

6 Leads Bipolar (Series) Connection

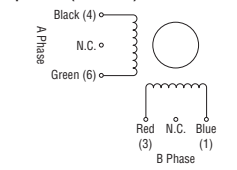

8 Leads Unipolar Connection

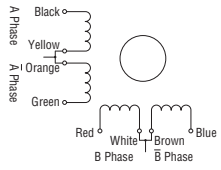

8 Leads Bipolar (Series) Connection

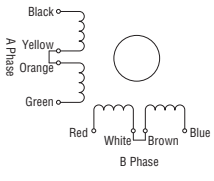

8 Leads Bipolar (Parallel) Connection

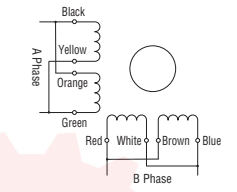

- The numbers inside the parentheses indicate the connector pin No. of the high-torque type motor.
- N.C.: No Connection

Standard Type Terminal Box

Motor Connections

PK26 DAT

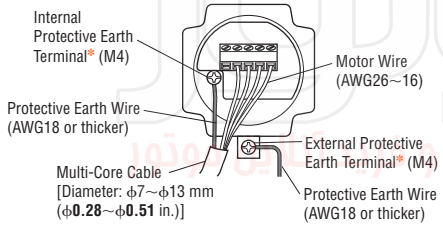

*Use either the internal or external protective earth terminal for grounding.

PK29 EAT

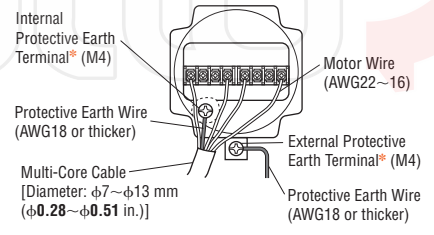

*Use either the internal or external protective earth terminal for grounding.

Wiring Connection Diagrams

PK26 DAT

Bipolar

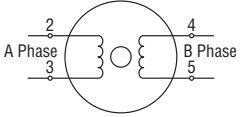

Connect motor lead wires to the terminals 2 to 5.

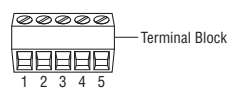

PK29 EAT

Bipolar (Series)

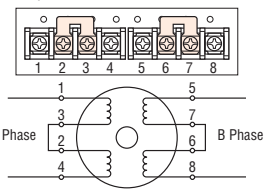

Bipolar (Parallel)

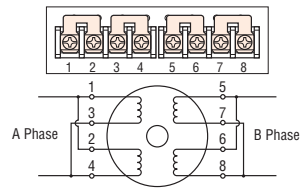

Unipolar

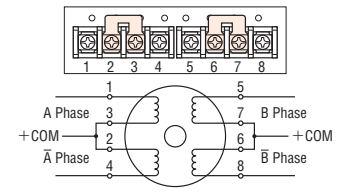

Notes on the Speed – Torque Characteristics Diagrams

The speed – torque characteristics featured in this catalog are measured with a constant-current driver or a constant-voltage driver. The actual characteristics will vary depending on the driver used. Please use these diagrams only for reference purposes when selecting a motor. You must also conduct a thorough evaluation with the actual driver to be used.

Product Specifications

Motor Frame Size: 28 mm (1.10 in.) **PK22**

Type	Model Single Shaft Double Shaft	Basic Step Angle	Connection Type	Holding Torque		Rated Current A/phase	Voltage VDC	Resistance Ω /phase	Inductance mH/phase	Rotor Inertia J		Page
				N-m	oz-in					kg-m ²	oz-in ²	
High-Torque Type	PK223PA PK223PB	1.8°	Bipolar (Series)	0.065	9.2	0.67	3.8	5.6	4	9×10^{-7}	0.049	C-218
			Unipolar	0.05	7.1	0.95	2.66	2.8	1			
	PK224PA PK224PB	1.8°	Bipolar (Series)	0.097	13.7	0.67	4.6	6.8	4.8	12×10^{-7}	0.066	
			Unipolar	0.075	10.6	0.95	3.2	3.4	1.2			
	PK225PA PK225PB	1.8°	Bipolar (Series)	0.11	15.6	0.67	6.2	9.2	5.6	18×10^{-7}	0.098	
			Unipolar	0.09	12.7	0.95	4.4	4.6	1.4			
SH Geared Type	PK223PA-SG7.2 PK223PB-SG7.2	0.25°	Bipolar (Series)	0.3	42	0.67	3.8	5.6	4	9×10^{-7}	0.049	C-220
			Unipolar	0.95	2.66	2.8	1					
	PK223PA-SG9 PK223PB-SG9	0.2°	Bipolar (Series)	0.3	42	0.67	3.8	5.6	4			
			Unipolar	0.95	2.66	2.8	1					
	PK223PA-SG10 PK223PB-SG10	0.18°	Bipolar (Series)	0.3	42	0.67	3.8	5.6	4			
			Unipolar	0.95	2.66	2.8	1					
	PK223PA-SG18 PK223PB-SG18	0.1°	Bipolar (Series)	0.4	56	0.67	3.8	5.6	4			
			Unipolar	0.95	2.66	2.8	1					
	PK223PA-SG36 PK223PB-SG36	0.05°	Bipolar (Series)	0.4	56	0.67	3.8	5.6	4			
			Unipolar	0.95	2.66	2.8	1					

● The value given for holding torque is the value when operated with rated voltage and 2-phase excitation.

Motor Frame Size: 35 mm (1.38 in.) **PK23**

Type	Model Single Shaft Double Shaft	Basic Step Angle	Connection Type	Holding Torque		Rated Current A/phase	Voltage VDC	Resistance Ω /phase	Inductance mH/phase	Rotor Inertia J		Page
				N-m	oz-in					kg-m ²	oz-in ²	
High-Torque Type	PK233PA PK233PB	1.8°	Bipolar (Series)	0.2	28	0.85	4.6	5.4	5.6	24×10^{-7}	0.131	C-222
			Unipolar	0.16	22	1.2	3.24	2.7	1.4			
	PK235PA PK235PB	1.8°	Bipolar (Series)	0.37	52	0.85	5.8	6.8	8	50×10^{-7}	0.27	
			Unipolar	0.3	42	1.2	4.08	3.4	2			

● The value given for holding torque is the value when operated with rated voltage and 2-phase excitation.

Motor Frame Size: 42 mm (1.65 in.) **PK24**

Type	Model Single Shaft Double Shaft	Basic Step Angle	Connection Type	Holding Torque		Rated Current A/phase	Voltage VDC	Resistance Ω /phase	Inductance mH/phase	Rotor Inertia J		Page
				N-m	oz-in					kg-m ²	oz-in ²	
Standard Type	PK243-01AA PK243-01BA	1.8°	Bipolar (Series)	0.2	28	0.67	5.6	8.4	10	35×10^{-7}	0.191	C-226
			Unipolar	0.16	22	0.95	4	4.2	2.5			
	PK243-02AA PK243-02BA		Bipolar (Series)	0.2	28	0.28	13	48	60			
			Unipolar	0.16	22	0.4	9.6	24	15			
	PK243-03AA PK243-03BA		Bipolar (Series)	0.2	28	0.22	17	77	84			
			Unipolar	0.16	22	0.31	12	38.5	21			
	PK244-01AA PK244-01BA		Bipolar (Series)	0.33	46	0.85	5.6	6.6	12.8			
			Unipolar	0.26	36	1.2	4	3.3	3.2			
	PK244-02AA PK244-02BA		Bipolar (Series)	0.33	46	0.57	8.6	15	26.8			
			Unipolar	0.26	36	0.8	6	7.5	6.7			
	PK244-03AA PK244-03BA		Bipolar (Series)	0.33	46	0.28	17	60	120			
			Unipolar	0.26	36	0.4	12	30	30			
	PK244-04AA PK244-04BA		Bipolar (Series)	0.33	46	0.14	34	240	428			
			Unipolar	0.26	36	0.2	24	120	107			
	PK245-01AA PK245-01BA		Bipolar (Series)	0.43	61	0.85	5.6	6.6	11.2			
			Unipolar	0.32	45	1.2	4	3.3	2.6			
	PK245-02AA PK245-02BA		Bipolar (Series)	0.43	61	0.57	8.6	15	28.4			
			Unipolar	0.32	45	0.8	6	7.5	7.1			
	PK245-03AA PK245-03BA		Bipolar (Series)	0.43	61	0.28	17	60	100			
			Unipolar	0.32	45	0.4	12	30	25			

● The value given for holding torque is the value when operated with rated voltage and 2-phase excitation.

The following items are included in each product.

Motor, Motor Lead Wire/Connector Assembly^{*1}, Encoder Cable^{*2},

Mounting Screws for Motor^{*3}, Operating Manual

*1 Only for connector-coupled motor

*2 Only for motor with encoder

*3 Only for SH geared type

Motor Frame Size: □42 mm (□1.65 in.) **PK24□**

Type	Model Single Shaft Double Shaft	Basic Step Angle	Connection Type	Holding Torque		Rated Current A/phase	Voltage VDC	Resistance Ω/phase	Inductance mH/phase	Rotor Inertia J		Page
				N-m	oz-in					kg-m ²	oz-in ²	
High-Torque Type	PK244PA	1.8°	Bipolar (Series)	0.48	68	0.85	6.8	8	15.6	57×10 ⁻⁷	0.31	C-224
	PK244PB		Unipolar	0.39	55	1.2	4.8	4	3.9			
	PK246PA		Bipolar (Series)	0.93	132	0.85	10	12	26	114×10 ⁻⁷	0.62	
	PK246PB		Unipolar	0.75	106	1.2	7.2	6	6.5			
High-Resolution Type	PK243M-01AA	0.9°	Bipolar (Series)	0.2	28	0.67	5.6	8.4	15.2	35×10 ⁻⁷	0.191	C-230
	PK243M-01BA		Unipolar	0.16	22	0.95	4	4.2	3.8			
	PK243M-02AA		Bipolar (Series)	0.2	28	0.42	8.4	20	38.8			
	PK243M-02BA		Unipolar	0.16	22	0.6	6	10	9.7			
	PK243M-03AA		Bipolar (Series)	0.2	28	0.22	17	77	136	34		
	PK243M-03BA		Unipolar	0.16	22	0.31	12	38.5				
	PK244M-01AA		Bipolar (Series)	0.31	44	0.85	5.6	6.6	17.2	4.3		
	PK244M-01BA		Unipolar	0.26	36	1.2	4	3.3				
	PK244M-02AA		Bipolar (Series)	0.31	44	0.57	8.6	15	38.8	54×10 ⁻⁷	0.3	
	PK244M-02BA		Unipolar	0.26	36	0.8	6	7.5	9.7			
	PK244M-03AA		Bipolar (Series)	0.31	44	0.28	17	60	152	38		
	PK244M-03BA		Unipolar	0.26	36	0.4	12	30				
	PK245M-01AA		Bipolar (Series)	0.38	53	0.85	5.6	6.6	15.6	68×10 ⁻⁷	0.37	
	PK245M-01BA		Unipolar	0.32	45	1.2	4	3.3	3.9			
	PK245M-02AA		Bipolar (Series)	0.38	53	0.57	8.6	15	39.6	9.9		
	PK245M-02BA		Unipolar	0.32	45	0.8	6	7.5				
PK245M-03AA	Bipolar (Series)	0.38	53	0.28	17	60	128	32				
PK245M-03BA	Unipolar	0.32	45	0.4	12	30						

● The value given for holding torque is the value when operated with rated voltage and 2-phase excitation.

Motor Frame Size: □42 mm (□1.65 in.) **PK243**

Type	Model Single Shaft Double Shaft	Basic Step Angle	Connection Type	Holding Torque		Rated Current A/phase	Voltage VDC	Resistance Ω/phase	Inductance mH/phase	Rotor Inertia J		Page		
				N-m	lb-in					kg-m ²	oz-in ²			
SH Geared Type	PK243A1A-SG3.6	0.5°	Bipolar (Series)	0.2	1.77	0.67	5.6	8.4	10	35×10 ⁻⁷	0.191	C-234		
	PK243B1A-SG3.6		Unipolar	0.95	4.0	4.2	2.5							
	PK243A1A-SG7.2	0.25°	Bipolar (Series)	0.4	3.5	0.67	5.6	8.4	10					
	PK243B1A-SG7.2		Unipolar	0.95	4.0	4.2	2.5							
	PK243A1A-SG9	0.2°	Bipolar (Series)	0.5	4.4	0.67	5.6	8.4	10					
	PK243B1A-SG9		Unipolar	0.95	4.0	4.2	2.5							
	PK243A1A-SG10	0.18°	Bipolar (Series)	0.56	4.9	0.67	5.6	8.4	10					
	PK243B1A-SG10		Unipolar	0.95	4.0	4.2	2.5							
	PK243A1A-SG18	0.1°	Bipolar (Series)	0.8	7.0	0.67	5.6	8.4	10					
	PK243B1A-SG18		Unipolar	0.95	4.0	4.2	2.5							
	PK243A1A-SG36	0.05°	Bipolar (Series)	0.8	7.0	0.67	5.6	8.4	10					
	PK243B1A-SG36		Unipolar	0.95	4.0	4.2	2.5							
	PK243A2A-SG3.6	0.5°	Bipolar (Series)	0.2	1.77	0.28	13	48	60				35×10 ⁻⁷	0.191
	PK243B2A-SG3.6		Unipolar	0.4	9.6	24	15							
	PK243A2A-SG7.2	0.25°	Bipolar (Series)	0.4	3.5	0.28	13	48	60					
	PK243B2A-SG7.2		Unipolar	0.4	9.6	24	15							
	PK243A2A-SG9	0.2°	Bipolar (Series)	0.5	4.4	0.28	13	48	60					
	PK243B2A-SG9		Unipolar	0.4	9.6	24	15							
	PK243A2A-SG10	0.18°	Bipolar (Series)	0.56	4.9	0.28	13	48	60					
	PK243B2A-SG10		Unipolar	0.4	9.6	24	15							
PK243A2A-SG18	0.1°	Bipolar (Series)	0.8	7.0	0.28	13	48	60						
PK243B2A-SG18		Unipolar	0.4	9.6	24	15								
PK243A2A-SG36	0.05°	Bipolar (Series)	0.8	7.0	0.28	13	48	60						
PK243B2A-SG36		Unipolar	0.4	9.6	24	15								

● The value given for holding torque is the value when operated with rated voltage and 2-phase excitation.

Motor Frame Size: □50mm (□1.97 in.) **PK25**□

Type	Model Single Shaft Double Shaft	Basic Step Angle	Connection Type	Holding Torque		Rated Current A/phase	Voltage VDC	Resistance Ω/phase	Inductance mH/phase	Rotor Inertia J		Page
				N-m	oz-in					kg-m ²	oz-in ²	
Standard Type	PK256-02A	1.8°	Bipolar (Series)	0.84	119	1.4	4.2	3	5.6	230×10 ⁻⁷	1.26	C-236
	PK256-02B		Unipolar	0.6	85	2	3	1.5	1.4			
	PK258-02A		Bipolar (Series)	1.56	220	1.4	6.7	4.8	11.5	420×10 ⁻⁷	2.3	
	PK258-02B		Unipolar	1.2	170	2	4.8	2.4	2.87			

● The value given for holding torque is the value when operated with rated voltage and 2-phase excitation.

Motor Frame Size: □56.4 mm (□2.22 in.) **PK26**□

Type	Model Single Shaft Double Shaft	Basic Step Angle	Connection Type	Holding Torque		Rated Current A/phase	Voltage VDC	Resistance Ω/phase	Inductance mH/phase	Rotor Inertia J		Page
				N-m	oz-in					kg-m ²	oz-in ²	
Standard Type	PK264-01A	1.8°	Bipolar (Series)	0.48	68	0.71	8.1	11.4	21.6	120×10 ⁻⁷	0.66	C-238
	PK264-01B		Unipolar	0.39	55	1	5.7	5.7	5.4			
	PK264-02A		Bipolar (Series)	0.48	68	1.4	3.9	2.8	5.6			
	PK264-02B		Unipolar	0.39	55	2	2.8	1.4	1.4			
	PK264-03A		Bipolar (Series)	0.48	68	2.1	2.6	1.26	2.4			
	PK264-03B		Unipolar	0.39	55	3	1.9	0.63	0.6			
	PK264-E2.0A		Bipolar (Parallel)	0.48	68	2.8	1.96	0.7	1.4			
	PK264-E2.0B		Bipolar (Series)	0.48	68	1.4	3.9	2.8	5.6			
	PK266-01A		Bipolar (Series)	1.17	166	0.71	11	14.8	40			
	PK266-01B		Unipolar	0.9	127	1	7.4	7.4	10			
	PK266-02A		Bipolar (Series)	1.17	166	1.4	5	3.6	10			
	PK266-02B		Unipolar	0.9	127	2	3.6	1.8	2.5			
	PK266-03A		Bipolar (Series)	1.17	166	2.1	3.2	1.5	4.4			
	PK266-03B		Unipolar	0.9	127	3	2.3	0.75	1.1			
	PK266-E2.0A		Bipolar (Parallel)	1.17	166	2.8	2.52	0.9	2.5			
	PK266-E2.0B		Bipolar (Series)	1.17	166	1.4	5	3.6	10			
	PK268-01A		Unipolar	0.9	127	2	3.6	1.8	2.5			
	PK268-01B		Bipolar (Series)	1.75	240	0.71	12	17.2	56			
	PK268-02A		Unipolar	1.35	191	1	8.6	8.6	14			
	PK268-02A		Bipolar (Series)	1.75	240	1.4	6.3	4.5	14.4			
	PK268-02B		Unipolar	1.35	191	2	4.5	2.25	3.6			
	PK268-03A		Bipolar (Series)	1.75	240	2.1	4.2	2	6.4			
	PK268-03B		Unipolar	1.35	191	3	3	1	1.6			
	PK268-E2.0A		Bipolar (Parallel)	1.75	240	2.8	3.16	1.13	3.6			
PK268-E2.0B	Bipolar (Series)	1.75	240	1.4	6.3	4.5	14.4					
PK268-E2.0B	Unipolar	1.35	191	2	4.5	2.25	3.6					
Standard Type	PK264DAT	1.8°	Bipolar	0.48	68	2.8	1.96	0.7	1.4	120×10 ⁻⁷	0.66	C-242
Terminal Box	PK266DAT		Bipolar	1.17	166	2.8	2.52	0.9	2.5	300×10 ⁻⁷	1.64	
	PK268DAT		Bipolar	1.75	240	2.8	3.16	1.13	3.6	480×10 ⁻⁷	2.6	
Standard Type with Encoder	PK264-01AR11	1.8°	Bipolar (Series)	0.48	68	0.71	8.1	11.4	21.6	120×10 ⁻⁷	0.66	C-261
	PK264-01AR12		Unipolar	0.39	55	1	5.7	5.7	5.4			
	PK264-02AR11		Bipolar (Series)	0.48	68	1.4	3.9	2.8	5.6			
	PK264-02AR12		Unipolar	0.39	55	2	2.8	1.4	1.4			
	PK264-03AR11		Bipolar (Series)	0.48	68	2.1	2.6	1.26	2.4			
	PK264-03AR12		Unipolar	0.39	55	3	1.9	0.63	0.6			
	PK264-E2.0AR11		Bipolar (Parallel)	0.48	68	2.8	1.96	0.7	1.4			
	PK264-E2.0AR12		Bipolar (Series)	0.48	68	1.4	3.9	2.8	5.6			
	PK266-01AR11		Unipolar	0.39	55	2	2.8	1.4	1.4			
	PK266-01AR12		Bipolar (Series)	1.17	166	0.71	11	14.8	40			
	PK266-02AR11		Unipolar	0.9	127	1	7.4	7.4	10			
	PK266-02AR12		Bipolar (Series)	1.17	166	1.4	5	3.6	10			
	PK266-02AR12		Unipolar	0.9	127	2	3.6	1.8	2.5			
	PK266-03AR11		Bipolar (Series)	1.17	166	2.1	3.2	1.5	4.4			
	PK266-03AR12		Unipolar	0.9	127	3	2.3	0.75	1.1			
	PK266-E2.0AR11		Bipolar (Parallel)	1.17	166	2.8	2.52	0.9	2.5			
	PK266-E2.0AR12		Bipolar (Series)	1.17	166	1.4	5	3.6	10			
			Unipolar	0.9	127	2	3.6	1.8	2.5			

● The value given for holding torque is the value when operated with rated voltage and 2-phase excitation.

Motor Frame Size: □56.4 mm (□2.22 in.) **PK26**□

Type	Model Single Shaft Double Shaft	Basic Step Angle	Connection Type	Holding Torque		Rated Current A/phase	Voltage VDC	Resistance Ω/phase	Inductance mH/phase	Rotor Inertia		Page
				N-m	oz-in					kg-m ²	oz-in ²	
High-Resolution Type	PK264M-01A PK264M-01B	0.9°	Bipolar (Series)	0.48	68	0.71	8.1	11.4	26	120×10 ⁻⁷	0.66	C-244
	Unipolar		0.39	55	1	5.7	5.7	6.5				
	PK264M-02A PK264M-02B		Bipolar (Series)	0.48	68	1.4	3.9	2.8	6.8			
	Unipolar		0.39	55	2	2.8	1.4	1.7				
	PK264M-03A PK264M-03B		Bipolar (Series)	0.48	68	2.1	2.6	1.26	3			
	Unipolar		0.39	55	3	1.9	0.63	0.75				
	PK264M-E2.0A PK264M-E2.0B		Bipolar (Parallel)	0.48	68	2.8	1.96	0.7	1.7			
	Bipolar (Series)		0.48	68	1.4	3.9	2.8	6.8				
	Unipolar		0.39	55	2	2.8	1.4	1.7				
	PK266M-01A PK266M-01B		Bipolar (Series)	1.17	166	0.71	11	14.8	50.8			
	Unipolar		0.9	127	1	7.4	7.4	12.7				
	PK266M-02A PK266M-02B		Bipolar (Series)	1.17	166	1.4	5	3.6	12.8			
	Unipolar		0.9	127	2	3.6	1.8	3.2				
	PK266M-03A PK266M-03B		Bipolar (Series)	1.17	166	2.1	3.2	1.5	5.8			
	Unipolar		0.9	127	3	2.3	0.75	1.45				
	PK266M-E2.0A PK266M-E2.0B		Bipolar (Parallel)	1.17	166	2.8	2.52	0.9	3.2			
	Bipolar (Series)		1.17	166	1.4	5	3.6	12.8				
	Unipolar		0.9	127	2	3.6	1.8	3.2				
	PK268M-01A PK268M-01B		Bipolar (Series)	1.75	240	0.71	12	17.2	77.6			
	Unipolar		1.35	191	1	8.6	8.6	19.4				
	PK268M-02A PK268M-02B		Bipolar (Series)	1.75	240	1.4	6.3	4.5	19.2			
	Unipolar		1.35	191	2	4.5	2.25	4.8				
	PK268M-03A PK268M-03B		Bipolar (Series)	1.75	240	2.1	4.2	2	8.4			
	Unipolar		1.35	191	3	3	1	2.1				
PK268M-E2.0A PK268M-E2.0B	Bipolar (Parallel)	1.75	240	2.8	3.16	1.13	4.8					
Bipolar (Series)	1.75	240	1.4	6.3	4.5	19.2						
Unipolar	1.35	191	2	4.5	2.25	4.8						
High-Resolution Type with Encoder	PK264M-01AR11 PK264M-01AR12	0.9°	Bipolar (Series)	0.48	68	0.71	8.1	11.4	26	120×10 ⁻⁷	0.66	C-264
	Unipolar		0.39	55	1	5.7	5.7	6.5				
	PK264M-02AR11 PK264M-02AR12		Bipolar (Series)	0.48	68	1.4	3.9	2.8	6.8			
	Unipolar		0.39	55	2	2.8	1.4	1.7				
	PK264M-03AR11 PK264M-03AR12		Bipolar (Series)	0.48	68	2.1	2.6	1.26	3			
	Unipolar		0.39	55	3	1.9	0.63	0.75				
	PK264M-E2.0AR11 PK264M-E2.0AR12		Bipolar (Parallel)	0.48	68	2.8	1.96	0.7	1.7			
	Bipolar (Series)		0.48	68	1.4	3.9	2.8	6.8				
	Unipolar		0.39	55	2	2.8	1.4	1.7				
	PK266M-01AR11 PK266M-01AR12		Bipolar (Series)	1.17	166	0.71	11	14.8	50.8			
	Unipolar		0.9	127	1	7.4	7.4	12.7				
	PK266M-02AR11 PK266M-02AR12		Bipolar (Series)	1.17	166	1.4	5	3.6	12.8			
	Unipolar		0.9	127	2	3.6	1.8	3.2				
	PK266M-03AR11 PK266M-03AR12		Bipolar (Series)	1.17	166	2.1	3.2	1.5	5.8			
	Unipolar		0.9	127	3	2.3	0.75	1.45				
	PK266M-E2.0AR11 PK266M-E2.0AR12		Bipolar (Parallel)	1.17	166	2.8	2.52	0.9	3.2			
	Bipolar (Series)		1.17	166	1.4	5	3.6	12.8				
	Unipolar		0.9	127	2	3.6	1.8	3.2				

● The value given for holding torque is the value when operated with rated voltage and 2-phase excitation.

Motor Frame Size: □56.4 mm (□2.22 in.) **PK264** Frame size of **SH** geared type is □60 mm (□2.36 in.).

Type	Model Single Shaft Double Shaft	Basic Step Angle	Connection Type	Holding Torque		Rated Current A/phase	Voltage VDC	Resistance Ω/phase	Inductance mH/phase	Rotor Inertia J		Page
				N-m	lb-in					kg-m ²	oz-in ²	
SH Geared Type	PK264A1A-SG3.6 PK264B1A-SG3.6	0.5°	Bipolar (Series) Unipolar	1	8.8	0.71 1	8.1 5.7	11.4 5.7	21.6 5.4	120×10 ⁻⁷	0.66	C-248
	PK264A1A-SG7.2 PK264B1A-SG7.2	0.25°	Bipolar (Series) Unipolar	2	17.7	0.71 1	8.1 5.7	11.4 5.7	21.6 5.4			
	PK264A1A-SG9 PK264B1A-SG9	0.2°	Bipolar (Series) Unipolar	2.5	22	0.71 1	8.1 5.7	11.4 5.7	21.6 5.4			
	PK264A1A-SG10 PK264B1A-SG10	0.18°	Bipolar (Series) Unipolar	2.7	23	0.71 1	8.1 5.7	11.4 5.7	21.6 5.4			
	PK264A1A-SG18 PK264B1A-SG18	0.1°	Bipolar (Series) Unipolar	3	26	0.71 1	8.1 5.7	11.4 5.7	21.6 5.4			
	PK264A1A-SG36 PK264B1A-SG36	0.05°	Bipolar (Series) Unipolar	4	35	0.71 1	8.1 5.7	11.4 5.7	21.6 5.4			
	PK264A2A-SG3.6 PK264B2A-SG3.6	0.5°	Bipolar (Series) Unipolar	1	8.8	1.4 2	3.9 2.8	2.8 1.4	5.6 1.4	120×10 ⁻⁷	0.66	
	PK264A2A-SG7.2 PK264B2A-SG7.2	0.25°	Bipolar (Series) Unipolar	2	17.7	1.4 2	3.9 2.8	2.8 1.4	5.6 1.4			
	PK264A2A-SG9 PK264B2A-SG9	0.2°	Bipolar (Series) Unipolar	2.5	22	1.4 2	3.9 2.8	2.8 1.4	5.6 1.4			
	PK264A2A-SG10 PK264B2A-SG10	0.18°	Bipolar (Series) Unipolar	2.7	23	1.4 2	3.9 2.8	2.8 1.4	5.6 1.4			
	PK264A2A-SG18 PK264B2A-SG18	0.1°	Bipolar (Series) Unipolar	3	26	1.4 2	3.9 2.8	2.8 1.4	5.6 1.4			
	PK264A2A-SG36 PK264B2A-SG36	0.05°	Bipolar (Series) Unipolar	4	35	1.4 2	3.9 2.8	2.8 1.4	5.6 1.4			

● The value given for holding torque is the value when operated with rated voltage and 2-phase excitation.

Motor Frame Size: □60 mm (□2.36 in.) **PV26□**

Type	Model Single Shaft Double Shaft	Basic Step Angle	Connection Type	Holding Torque		Rated Current A/phase	Voltage VDC	Resistance Ω/phase	Inductance mH/phase	Rotor Inertia J		Page
				N-m	oz-in					kg-m ²	oz-in ²	
PV Series (High inertia capability)	PV264-02AA PV264-02BA	1.8°	Bipolar (Series) Unipolar	1.06 0.75	150 106	1.4 2	4.1 2.9	2.92 1.46	7.2 1.8	280×10 ⁻⁷	1.53	C-250
	PV264-D2.8AA PV264-D2.8BA		Bipolar	1.06	150	2.8	2.1	0.73	1.8			
	PV266-02AA PV266-02BA		Bipolar (Series) Unipolar	1.75 1.35	240 191	1.4 2	5.6 4	4 2	12.2 3.05	450×10 ⁻⁷	2.5	
	PV266-D2.8AA PV266-D2.8BA		Bipolar	1.75	240	2.8	2.8	1	3.05			
	PV267-02AA PV267-02BA		Bipolar (Series) Unipolar	2.2 1.7	310 240	1.4 2	6.7 4.8	4.8 2.4	14.2 3.54	570×10 ⁻⁷	3.1	
	PV267-D2.8AA PV267-D2.8BA		Bipolar	2.2	310	2.8	3.4	1.2	3.54			
	PV269-02AA PV269-02BA		Bipolar (Series) Unipolar	3.1 2.2	440 310	1.4 2	8.3 6	5.96 2.98	22.8 5.7	900×10 ⁻⁷	4.9	
	PV269-D2.8AA PV269-D2.8BA		Bipolar	3.1	440	2.8	4.2	1.49	5.7			

● The value given for holding torque is the value when operated with rated voltage and 2-phase excitation.

Motor Frame Size: □85 mm (□3.35 in.) **PK29□**

Type	Model Single Shaft Double Shaft	Basic Step Angle	Connection Type	Holding Torque		Rated Current A/phase	Voltage VDC	Resistance Ω/phase	Inductance mH/phase	Rotor Inertia J		Page
				N-m	oz-in					kg-m ²	oz-in ²	
Standard Type	PK296-01AA PK296-01BA	1.8°	Bipolar (Series) Unipolar	3.1 2.2	440 310	1.4 2	6.2 4.4	4.4 2.2	30.8 7.7	1400×10 ⁻⁷	7.7	C-253
	PK296-02AA PK296-02BA		Bipolar (Series) Unipolar	3.1 2.2	440 310	2.1 3	4.2 3	2 1	14 3.5			
	PK296-03AA PK296-03BA		Bipolar (Series) Unipolar	3.1 2.2	440 310	3.18 4.5	2.8 2	0.96 0.48	6 1.5			
	PK296-F4.5A PK296-F4.5B		Bipolar (Parallel) Bipolar (Series) Unipolar	3.1 3.1 2.2	440 440 310	6.3 3.18 4.5	1.4 2.8 2	0.24 0.96 0.48	1.5 6 1.5			

● The value given for holding torque is the value when operated with rated voltage and 2-phase excitation.

Motor Frame Size: □85 mm (□3.35 in.) **PK29**□

Type	Model Single Shaft Double Shaft	Basic Step Angle	Connection Type	Holding Torque		Rated Current A/phase	Voltage VDC	Resistance Ω/phase	Inductance mH/phase	Rotor Inertia J		Page
				N-m	oz-in					kg-m ²	oz-in ²	
Standard Type	PK299-01AA PK299-01BA	1.8°	Bipolar (Series)	6.2	880	1.4	9	6.4	56	2700×10 ⁻⁷	14.8	C-253
			Unipolar	4.4	620	2	6.4	3.2	14			
	PK299-02AA PK299-02BA	1.8°	Bipolar (Series)	6.2	880	2.1	6	3	24	2700×10 ⁻⁷	14.8	
			Unipolar	4.4	620	3	4.2	1.5	6			
	PK299-03AA PK299-03BA	1.8°	Bipolar (Series)	6.2	880	3.18	3.9	1.32	10	2700×10 ⁻⁷	14.8	
			Unipolar	4.4	620	4.5	2.8	0.66	2.5			
	PK299-F4.5A PK299-F4.5B	1.8°	Bipolar (Parallel)	6.2	880	6.3	1.9	0.33	2.5	2700×10 ⁻⁷	14.8	
			Bipolar (Series)	6.2	880	3.18	3.9	1.32	10			
	PK2913-01AA PK2913-01BA	1.8°	Bipolar (Series)	9.3	1320	1.4	10	7.6	76.8	4000×10 ⁻⁷	22	
			Unipolar	6.6	930	2	7.6	3.8	19.2			
	PK2913-02AA PK2913-02BA	1.8°	Bipolar (Series)	9.3	1320	2.8	5.3	1.94	16.8	4000×10 ⁻⁷	22	
			Unipolar	6.6	930	4	3.8	0.97	4.2			
	PK2913-F4.0A PK2913-F4.0B	1.8°	Bipolar (Parallel)	9.3	1320	5.6	2.6	0.49	4.2	4000×10 ⁻⁷	22	
			Bipolar (Series)	9.3	1320	2.8	5.3	1.94	16.8			
PK296EAT	1.8°	Bipolar (Parallel)	3.1	440	6.3	1.4	0.24	1.5	1400×10 ⁻⁷	7.7		
		Bipolar (Series)	3.1	440	3.18	2.8	0.96	6.0				
PK299EAT	1.8°	Unipolar	2.2	310	4.5	2	0.48	1.5	2700×10 ⁻⁷	14.8		
		Bipolar (Parallel)	6.2	880	6.3	1.9	0.33	2.5				
PK2913EAT	1.8°	Bipolar (Series)	6.2	880	3.13	3.9	1.32	10.0	4000×10 ⁻⁷	22		
		Unipolar	4.4	620	4.5	2.8	0.66	2.5				
PK2913EAT	1.8°	Bipolar (Parallel)	9.3	1320	5.6	2.6	0.49	4.2	4000×10 ⁻⁷	22		
		Bipolar (Series)	9.3	1320	2.8	5.3	1.94	16.8				
PK2913EAT	1.8°	Unipolar	6.6	930	4	2.8	0.97	4.2	4000×10 ⁻⁷	22		
		Unipolar	6.6	930	4	2.8	0.97	4.2				

● The value given for holding torque is the value when operated with rated voltage and 2-phase excitation.

Motor Frame Size: □85 mm (□3.35 in.) **PK296** Frame size of **SH** geared type is □90 mm (□3.54 in.).

Type	Model Single Shaft Double Shaft	Basic Step Angle	Connection Type	Holding Torque		Rated Current A/phase	Voltage VDC	Resistance Ω/phase	Inductance mH/phase	Rotor Inertia J		Page
				N-m	lb-in					kg-m ²	oz-in ²	
SH Geared Type	PK296A1A-SG3.6 PK296B1A-SG3.6	0.5°	Bipolar (Series)	2.5	22	1	4.4	4.4	30.8	1400×10 ⁻⁷	7.7	C-259
			Unipolar	1.5	3.3	2.2	7.7					
	PK296A1A-SG7.2 PK296B1A-SG7.2	0.25°	Bipolar (Series)	5	44	1	4.4	4.4	30.8	1400×10 ⁻⁷	7.7	
			Unipolar	1.5	3.3	2.2	7.7					
	PK296A1A-SG9 PK296B1A-SG9	0.2°	Bipolar (Series)	6.3	55	1	4.4	4.4	30.8	1400×10 ⁻⁷	7.7	
			Unipolar	1.5	3.3	2.2	7.7					
	PK296A1A-SG10 PK296B1A-SG10	0.18°	Bipolar (Series)	7	61	1	4.4	4.4	30.8	1400×10 ⁻⁷	7.7	
			Unipolar	1.5	3.3	2.2	7.7					
	PK296A1A-SG18 PK296B1A-SG18	0.1°	Bipolar (Series)	9	79	1	4.4	4.4	30.8	1400×10 ⁻⁷	7.7	
			Unipolar	1.5	3.3	2.2	7.7					
	PK296A1A-SG36 PK296B1A-SG36	0.05°	Bipolar (Series)	12	106	1	4.4	4.4	30.8	1400×10 ⁻⁷	7.7	
			Unipolar	1.5	3.3	2.2	7.7					
	PK296A2A-SG3.6 PK296B2A-SG3.6	0.5°	Bipolar (Series)	2.5	22	2.1	2	0.96	6	1400×10 ⁻⁷	7.7	
			Unipolar	3	1.4	0.48	1.5					
	PK296A2A-SG7.2 PK296B2A-SG7.2	0.25°	Bipolar (Series)	5	44	2.1	2	0.96	6	1400×10 ⁻⁷	7.7	
			Unipolar	3	1.4	0.48	1.5					
	PK296A2A-SG9 PK296B2A-SG9	0.2°	Bipolar (Series)	6.3	55	2.1	2	0.96	6	1400×10 ⁻⁷	7.7	
			Unipolar	3	1.4	0.48	1.5					
	PK296A2A-SG10 PK296B2A-SG10	0.18°	Bipolar (Series)	7	61	2.1	2	0.96	6	1400×10 ⁻⁷	7.7	
			Unipolar	3	1.4	0.48	1.5					
	PK296A2A-SG18 PK296B2A-SG18	0.1°	Bipolar (Series)	9	79	2.1	2	0.96	6	1400×10 ⁻⁷	7.7	
			Unipolar	3	1.4	0.48	1.5					
	PK296A2A-SG36 PK296B2A-SG36	0.05°	Bipolar (Series)	12	106	2.1	2	0.96	6	1400×10 ⁻⁷	7.7	
			Unipolar	3	1.4	0.48	1.5					

● The value given for holding torque is the value when operated with rated voltage and 2-phase excitation.

□ 28 mm (□ 1.10 in.)

Step Angle 1.8°

PK Series High-Torque Type

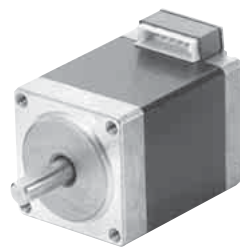

Specifications RoHS

Model Single Shaft Double Shaft	Connection Type	Holding Torque		Rated Current A/phase	Voltage VDC	Resistance Ω/phase	Inductance mH/phase	Rotor Inertia J		Lead Wires (Pins)	Corresponding DC-Input Motor & Driver Package
		N-m	oz-in					kg-m ²	oz-in ²		
PK223PA PK223PB	Bipolar (Series)	0.065	9.2	0.67	3.8	5.6	4	9×10 ⁻⁷	0.049	6	CMK223P□P
	Unipolar	0.05	7.1	0.95	2.66	2.8	1				
PK224PA PK224PB	Bipolar (Series)	0.097	13.7	0.67	4.6	6.8	4.8	12×10 ⁻⁷	0.066	6	CMK224P□P
	Unipolar	0.075	10.6	0.95	3.2	3.4	1.2				
PK225PA PK225PB	Bipolar (Series)	0.11	15.6	0.67	6.2	9.2	5.6	18×10 ⁻⁷	0.098	6	CMK225P□P
	Unipolar	0.09	12.7	0.95	4.4	4.6	1.4				

How to read specifications table → Page C-11

Wirings and connections → Page C-211

● Enter **A** (single shaft) or **B** (double shaft) in the box (□) within the model name.

Dimensions Unit = mm (in.)

Model	L1	L2	Mass kg (lb.)	DXF
PK223PA PK223PB	32 (1.26)	—	0.11 (0.24)	B326
PK224PA PK224PB	40 (1.57)	—	0.14 (0.31)	B327
PK225PA PK225PB	51.5 (2.03)	—	0.2 (0.44)	B328

● Lead wire and connector will not be supplied with the connector-coupled motor. They must be purchased separately.

Motor lead wire/connector assembly is available as an accessory (sold separately).

● Applicable Connector

Connector housing: 51065-0600 (MOLEX)

Contact: 50202-8100 (MOLEX)

Crimp tool: 57176-5000 (MOLEX)

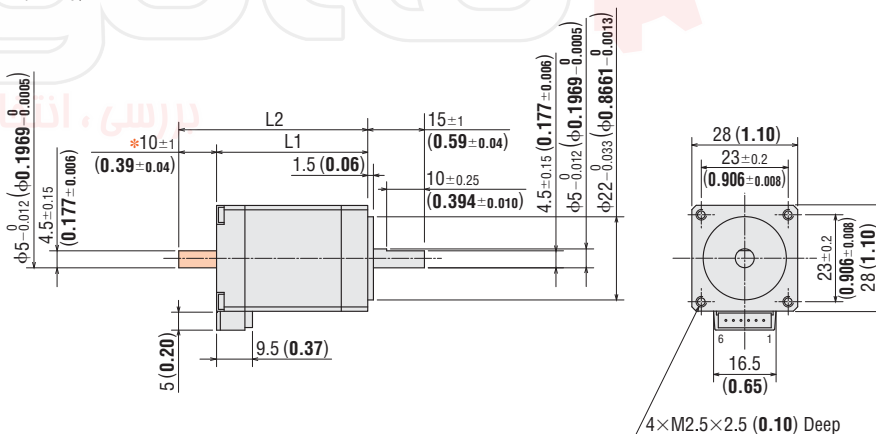

* The length of machining on the double shaft model is 10±0.25 (0.394±0.010).

● These dimensions are for the double shaft models. For the single shaft models, ignore the orange (■) area.

Speed – Torque Characteristics

How to read speed – torque characteristics → Page C-12

PK223PB Bipolar (Series)

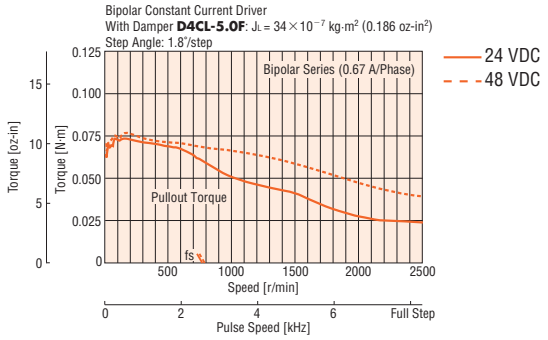

PK223PB Unipolar

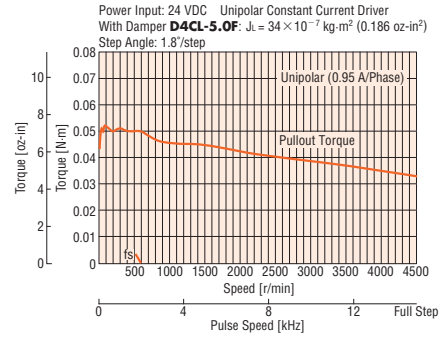

PK224PB Bipolar (Series)

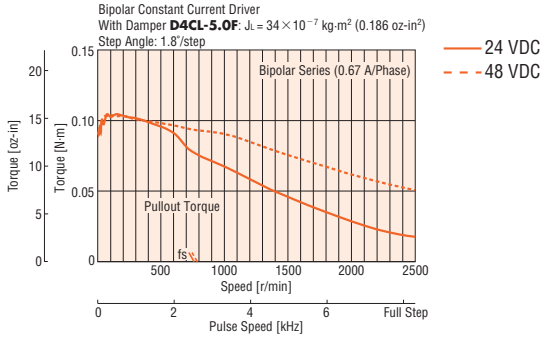

PK224PB Unipolar

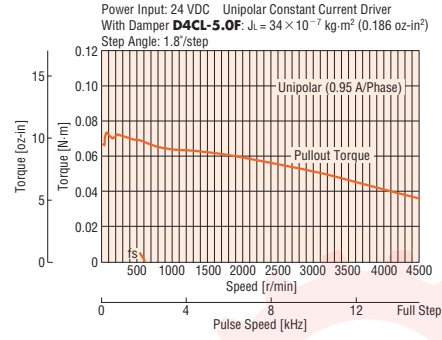

PK225PB Bipolar (Series)

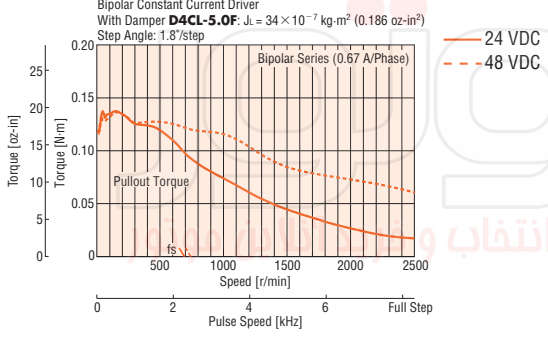

PK225PB Unipolar

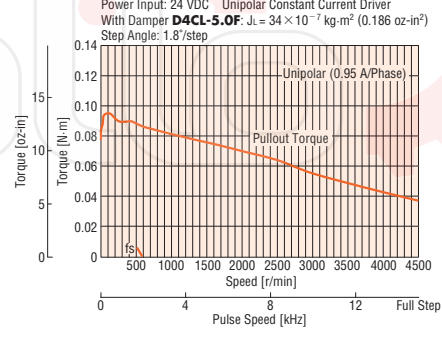

Note:

- Pay attention to heat dissipation from motor as there will be a considerable amount of heat under certain conditions. Be sure to keep the temperature of the motor case under 100°C (212°F).

Motor Lead Wire/Connector Assembly (Sold separately)

These cables make it easy to connect the high-torque type motor. The crimped connectors eliminate the need for assembly. There are two cable lengths to choose from.

Model	Cable Length m (ft.)	Number of Leads	Lead Specifications	
			UL Style No.	AWG No.
LC2U06A	0.6 (2)	6 Leads	3265	24
LC2U10A	1 (3.3)			



28 mm (1.10 in.)

PK Series SH Geared Type



Specifications (RoHS)

Motor Specifications

Model Single Shaft Double Shaft	Connection Type	Rated Current	Voltage	Resistance	Inductance	Rotor Inertia J		Lead Wires (Pins)	Corresponding DC-Input Motor & Driver Package
		A/phase	VDC	Ω /phase	mH/phase	kg-m ²	oz-in ²		
PK223PA-SG <input type="checkbox"/>	Bipolar (Series)	0.67	3.8	5.6	4	9×10^{-7}	0.049	6	CMK223 <input type="checkbox"/> P-SG <input type="checkbox"/>
PK223PB-SG <input type="checkbox"/>	Unipolar	0.95	2.66	2.8	1				

How to read specifications table → Page C-11

Wirings and connections → Page C-211

- Enter **A** (single shaft) or **B** (double shaft) in the box (□) within the model name.
- Enter the gear ratio in the box (■) within the model name.

Gearmotor Specifications

Model Single Shaft Double Shaft	Gear Ratio	Holding Torque*		Step Angle	Permissible Speed r/min
		N-m	oz-in		
PK223PA-SG7.2 <input type="checkbox"/> PK223PB-SG7.2 <input type="checkbox"/>	7.2:1	0.3	42	0.25°	250
PK223PA-SG9 <input type="checkbox"/> PK223PB-SG9 <input type="checkbox"/>	9:1	0.3	42	0.2°	200
PK223PA-SG10 <input type="checkbox"/> PK223PB-SG10 <input type="checkbox"/>	10:1	0.3	42	0.18°	180
PK223PA-SG18 <input type="checkbox"/> PK223PB-SG18 <input type="checkbox"/>	18:1	0.4	56	0.1°	100
PK223PA-SG36 <input type="checkbox"/> PK223PB-SG36 <input type="checkbox"/>	36:1	0.4	56	0.05°	50

* Holding torque is the same regardless of the connection type, due to the permissible torque limit of the gearhead.

Dimensions Unit = mm (in.)

Model	Mass kg (lb.)	DXF
PK223PA-SG <input type="checkbox"/>	0.16 (0.35)	B335
PK223PB-SG <input type="checkbox"/>		

- Enter the gear ratio in the box (□) within the model name.
- Lead wire and connector will not be supplied with the connector-coupled motor. They must be purchased separately. Motor lead wire/connector assembly is available as an accessory (sold separately).
- Screws (Included)
M2.5 Length 8 mm (0.31 in.)...4 pieces
- Applicable Connector
Connector housing: 51065-0600 (MOLEX)
Contact: 50202-8100 (MOLEX)
Crimp tool: 57176-5000 (MOLEX)

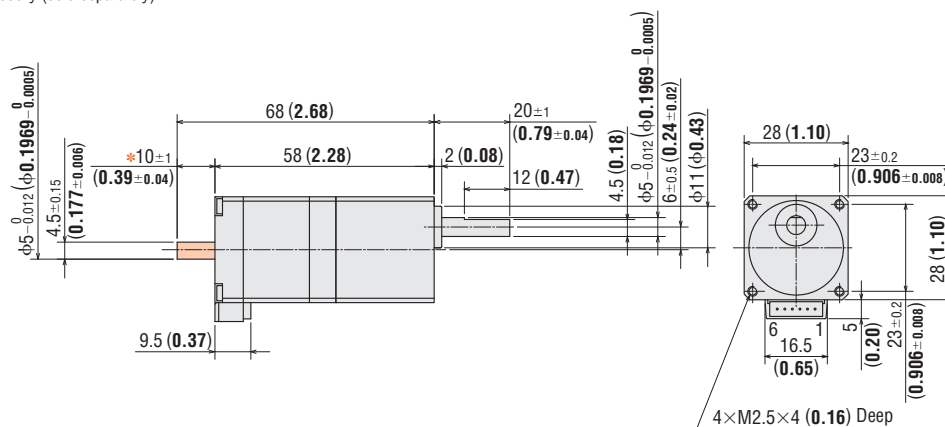

* The length of machining on the double shaft model is 10 ± 0.25 (0.394±0.010).

- These dimensions are for the double shaft models. For the single shaft models, ignore the orange (■) area.

Speed – Torque Characteristics

How to read speed – torque characteristics → Page C-12

PK223PB-SG Bipolar (Series) 24 VDC

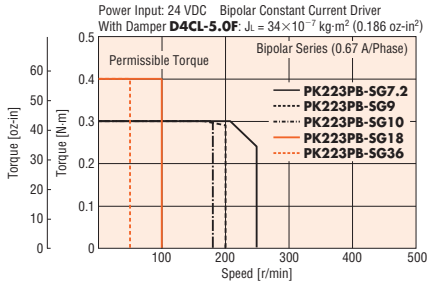

PK223PB-SG Unipolar

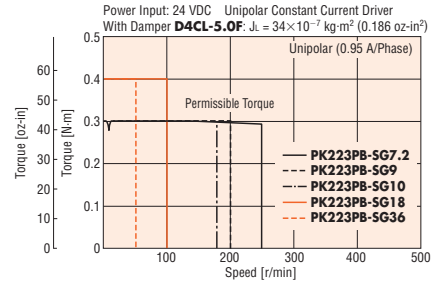

PK223PB-SG Bipolar (Series) 48 VDC

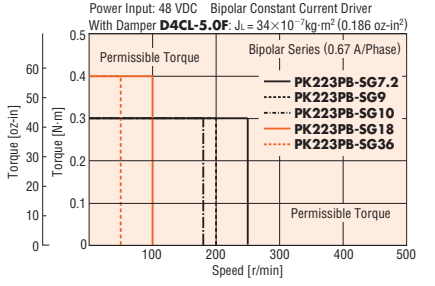

Note:

- Pay attention to heat dissipation from motor as there will be a considerable amount of heat under certain conditions. Be sure to keep the temperature of the motor case under 100°C (212°F).

Motor Lead Wire/Connector Assembly (Sold separately)

These cables make it easy to connect the high-torque type motor. The crimped connectors eliminate the need for assembly. There are two cable lengths to choose from.

Model	Cable Length m (ft.)	Number of Leads	Lead Specifications	
			UL Style No.	AWG No.
LC2U06A	0.6 (2)	6 Leads	3265	24
LC2U10A	1 (3.3)			

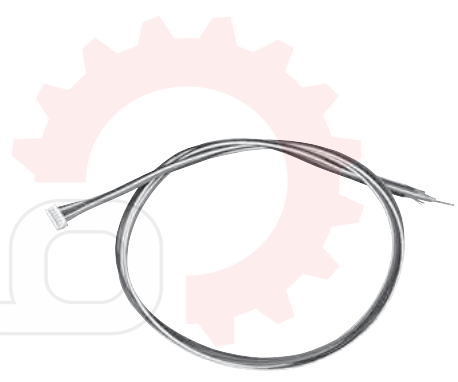

بررسی، انتخاب و خرید آنلاین موتور

- Introduction
- AC Input *QSTEP AS*
- DC Input *QSTEP ASG*
- 5-Phase Microstep *RK* AC Input
- 2-Phase Full/Half *UMK* AC Input
- 5-Phase Microstep *CMK* DC Input
- 2-Phase Microstep *RBK* DC Input
- 2-Phase Microstep *CMK* DC Input
- 2-Phase *PK/PV* Without Encoder
- 2-Phase *PK* With Encoder
- EMP400* Controllers
- SG8030J* Accessories
- Installation

□ 35 mm (□ 1.38 in.)

Step Angle 1.8°

PK Series High-Torque Type



Specifications RoHS

Model	Connection Type	Holding Torque		Rated Current	Voltage	Resistance	Inductance	Rotor Inertia J		Lead Wires (Pins)	Corresponding DC-Input Motor & Driver Package
		N-m	oz-in					kg-m ²	oz-in ²		
Single Shaft											
Double Shaft											
PK233PA	Bipolar (Series)	0.2	28	0.85	4.6	5.4	5.6	24 × 10 ⁻⁷	0.131	6	CMK233P□P
PK233PB	Unipolar	0.16	22	1.2	3.24	2.7	1.4				
PK235PA	Bipolar (Series)	0.37	52	0.85	5.8	6.8	8	50 × 10 ⁻⁷	0.27	6	CMK235P□P
PK235PB	Unipolar	0.3	42	1.2	4.08	3.4	2				

How to read specifications table → Page C-11

Wirings and connections → Page C-211

● Enter **A** (single shaft) or **B** (double shaft) in the box (□) within the model name.

Dimensions Unit = mm (in.)

Model	L1	L2	Mass kg (lb.)	DXF
PK233PA	37 (1.46)	-	0.18 (0.4)	B329
PK233PB		52 (2.05)		
PK235PA	52 (2.05)	-	0.285 (0.63)	B330
PK235PB		67 (2.64)		

● Lead wire and connector will not be supplied with the connector-coupled motor. They must be purchased separately.

Motor lead wire/connector assembly is available as an accessory (sold separately).

● Applicable Connector

Connector housing: 51103-0600 (MOLEX, Positive lock type) or

51102-0600 (MOLEX, Friction lock type)

Contact: 50351-8100 (MOLEX)

Crimp tool: 57295-5000 (MOLEX)

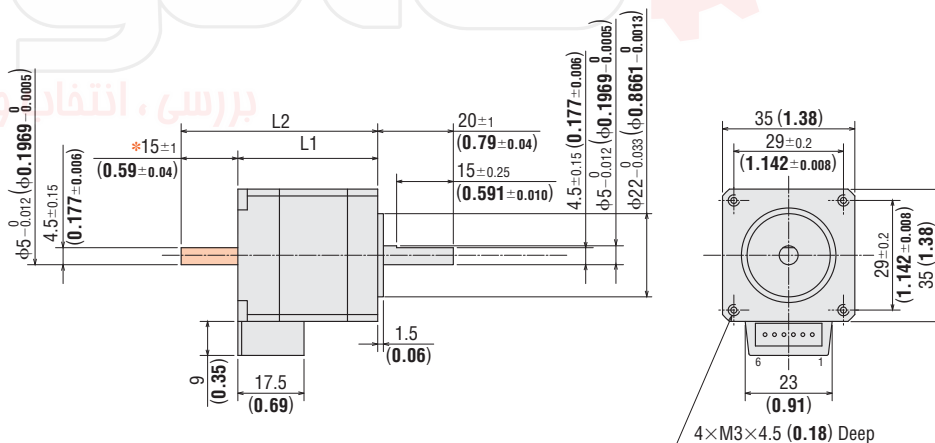

* The length of machining on the double shaft model is 15 ± 0.25 (0.591 ± 0.010).

● These dimensions are for the double shaft models. For the single shaft models, ignore the orange () area.

Speed – Torque Characteristics

How to read speed – torque characteristics → Page C-12

PK233PB Bipolar (Series)

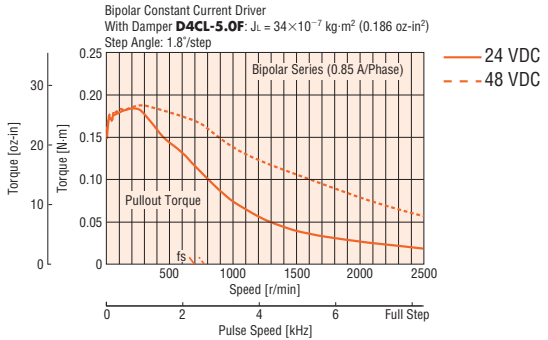

PK233PB Unipolar

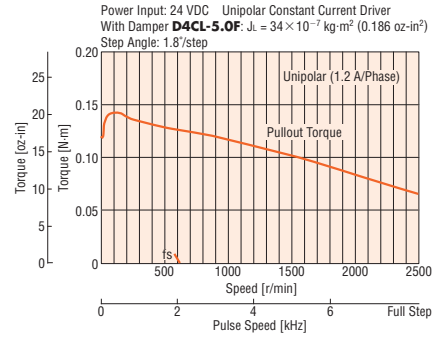

PK235PB Bipolar (Series)

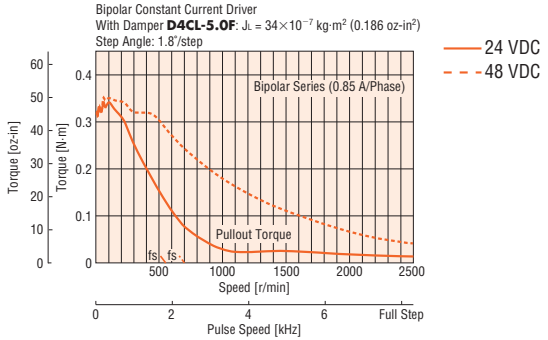

PK235PB Unipolar

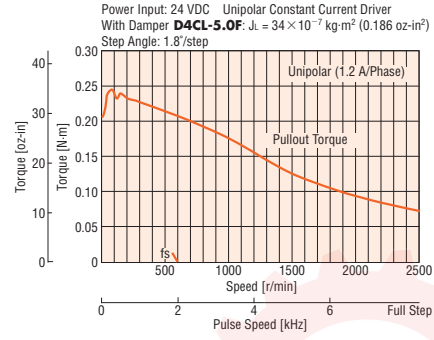

Note:

- Pay attention to heat dissipation from motor as there will be a considerable amount of heat under certain conditions. Be sure to keep the temperature of the motor case under 100°C (212°F).

Motor Lead Wire/Connector Assembly (Sold separately)

These cables make it easy to connect the high-torque type motor. The crimped connectors eliminate the need for assembly. There are two cable lengths to choose from.

Model	Cable Length m (ft.)	Number of Leads	Lead Specifications	
			UL Style No.	AWG No.
LC2U06B	0.6 (2)	6 Leads	3265	24
LC2U10B	1 (3.3)			

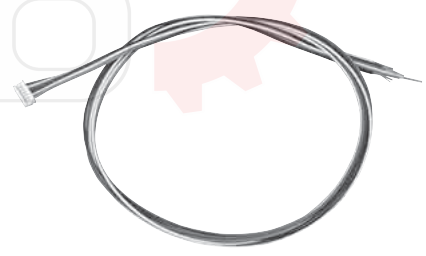

- Introduction
- AC Input **QSTEP AS**
- DC Input **QSTEP ASG**
- AC Input **5-Phase Microstep RK**
- AC Input **2-Phase Full/Half UMK**
- DC Input **5-Phase Microstep CMK**
- DC Input **2-Phase Microstep RBK**
- DC Input **2-Phase Microstep CMK**
- Without Encoder **2-Phase PK/PV**
- With Encoder **2-Phase PK**
- Controllers **EMP400**
- Controllers **SG8030J**
- Accessories
- Installation

42 mm (1.65 in.)

Step Angle 1.8°

PK Series High-Torque Type

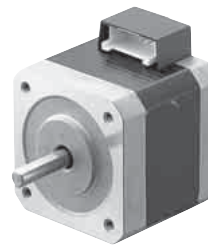

Specifications (RoHS)

Model	Connection Type	Holding Torque		Rated Current	Voltage	Resistance	Inductance	Rotor Inertia J		Lead Wires (Pins)	Corresponding DC-Input Motor & Driver Package
		N-m	oz-in					kg-m ²	oz-in ²		
Single Shaft	Bipolar (Series)	0.48	68	0.85	6.8	8	15.6	57×10 ⁻⁷	0.31	6	CMK244P□P
Double Shaft											
PK244PA	Bipolar (Series)	0.93	132	0.85	10	12	26	114×10 ⁻⁷	0.62	6	CMK246P□P

How to read specifications table → Page C-11

Wirings and connections → Page C-211

● Enter **A** (single shaft) or **B** (double shaft) in the box (□) within the model name.

Dimensions Unit = mm (in.)

Model	L1	L2	Mass kg (lb.)	DXF
PK244PA	39 (1.54)	-	0.3 (0.66)	B331
PK244PB		54 (2.13)		
PK246PA	59 (2.32)	-	0.5 (1.1)	B332
PK246PB		74 (2.91)		

● Lead wire and connector will not be supplied with the connector-coupled motor. They must be purchased separately.

Motor lead wire/connector assembly is available as an accessory (sold separately).

● Applicable Connector

Connector housing: 51103-0600 (MOLEX, Positive lock type) or 51102-0600 (MOLEX, Friction lock type)

Contact: 50351-8100 (MOLEX)

Crimp tool: 57295-5000 (MOLEX)

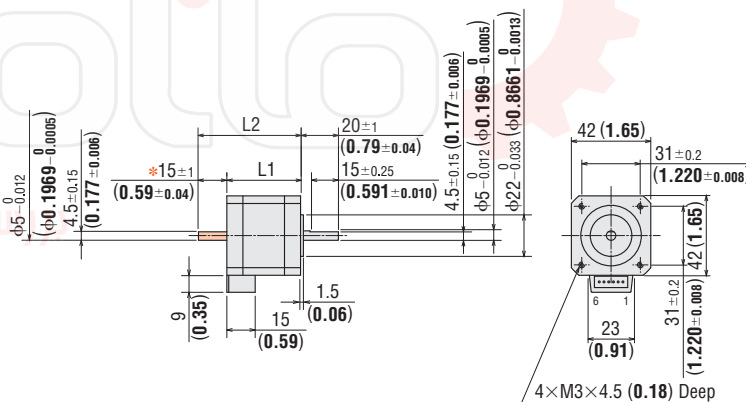

* The length of machining on the double shaft model is 15±0.25 (0.591±0.010).

● These dimensions are for the double shaft models. For the single shaft models, ignore the orange () area.

Speed – Torque Characteristics

How to read speed – torque characteristics → Page C-12

PK244PB Bipolar (Series)

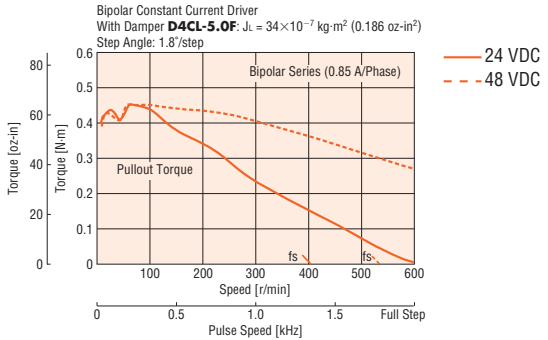

PK244PB Unipolar

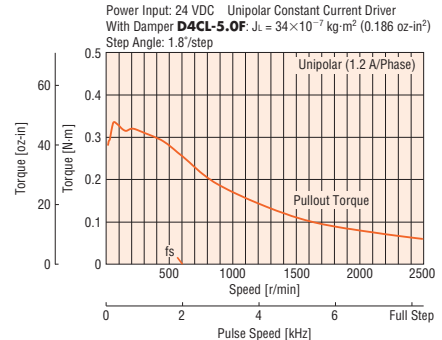

PK246PB Bipolar (Series)

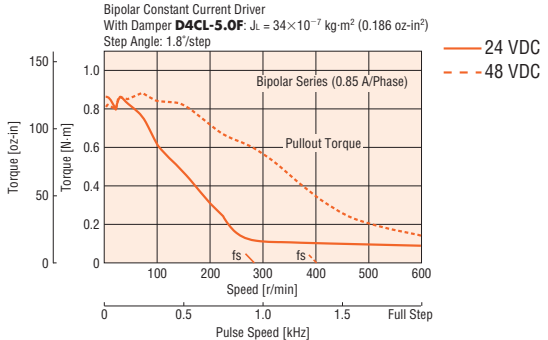

PK246PB Unipolar

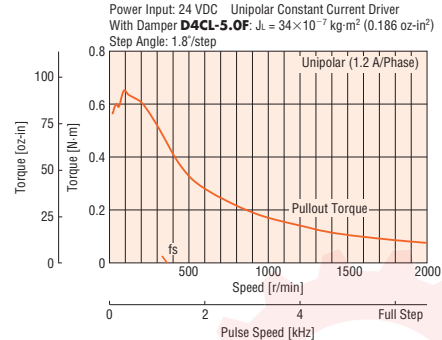

Note:

- Pay attention to heat dissipation from motor as there will be a considerable amount of heat under certain conditions. Be sure to keep the temperature of the motor case under 100°C (212°F).

Motor Lead Wire/Connector Assembly (Sold separately)

These cables make it easy to connect the high-torque type motor. The crimped connectors eliminate the need for assembly. There are two cable lengths to choose from.

Model	Cable Length m (ft.)	Number of Leads	Lead Specifications	
			UL Style No.	AWG No.
LC2U06B	0.6 (2)	6 Leads	3265	24
LC2U10B	1 (3.3)			

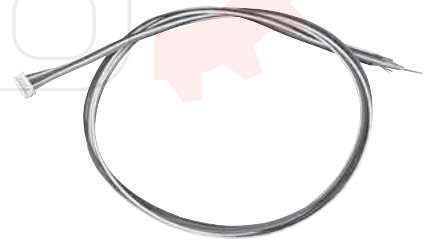

- Introduction
- AC Input *QSTEP AS*
- DC Input *QSTEP ASC*
- AC Input 5-Phase Microstep *RK*
- AC Input 2-Phase Full/Half *UMK*
- DC Input 5-Phase Microstep *CMK*
- DC Input 2-Phase Microstep *RBK*
- DC Input 2-Phase Microstep *CMK*
- Without Encoder 2-Phase *PK/PV*
- With Encoder 2-Phase *PK*
- Controllers *EMP400* *SG8030J*
- Accessories
- Installation

42 mm (1.65 in.)

Step Angle 1.8°

PK Series Standard Type

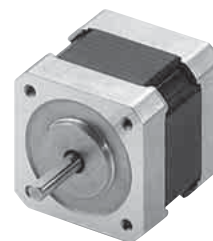

Specifications RoHS

Model	Connection Type	Holding Torque		Rated Current	Voltage	Resistance	Inductance	Rotor Inertia J		Lead Wires	Corresponding AC/DC-Input Motor & Driver Package
		N-m	oz-in					kg-m ²	oz-in ²		
PK243-01AA	Bipolar (Series)	0.2	28	0.67	5.6	8.4	10	35×10 ⁻⁷	0.191	6	UMK243□A/ CMK243□PA
PK243-01BA	Unipolar	0.16	22	0.95	4	4.2	2.5				
PK243-02AA	Bipolar (Series)	0.2	28	0.28	13	48	60	35×10 ⁻⁷	0.191	6	-
PK243-02BA	Unipolar	0.16	22	0.4	9.6	24	15				
PK243-03AA	Bipolar (Series)	0.2	28	0.22	17	77	84	35×10 ⁻⁷	0.191	6	-
PK243-03BA	Unipolar	0.16	22	0.31	12	38.5	21				
PK244-01AA	Bipolar (Series)	0.33	46	0.85	5.6	6.6	12.8	54×10 ⁻⁷	0.3	6	UMK244□A/ CMK244□PA
PK244-01BA	Unipolar	0.26	36	1.2	4	3.3	3.2				
PK244-02AA	Bipolar (Series)	0.33	46	0.57	8.6	15	26.8	54×10 ⁻⁷	0.3	6	-
PK244-02BA	Unipolar	0.26	36	0.8	6	7.5	6.7				
PK244-03AA	Bipolar (Series)	0.33	46	0.28	17	60	120	54×10 ⁻⁷	0.3	6	-
PK244-03BA	Unipolar	0.26	36	0.4	12	30	30				
PK244-04AA	Bipolar (Series)	0.33	46	0.14	34	240	428	54×10 ⁻⁷	0.3	6	-
PK244-04BA	Unipolar	0.26	36	0.2	24	120	107				
PK245-01AA	Bipolar (Series)	0.43	61	0.85	5.6	6.6	11.2	68×10 ⁻⁷	0.37	6	UMK245□A/ CMK245□PA
PK245-01BA	Unipolar	0.32	45	1.2	4	3.3	2.8				
PK245-02AA	Bipolar (Series)	0.43	61	0.57	8.6	15	28.4	68×10 ⁻⁷	0.37	6	-
PK245-02BA	Unipolar	0.32	45	0.8	6	7.5	7.1				
PK245-03AA	Bipolar (Series)	0.43	61	0.28	17	60	100	68×10 ⁻⁷	0.37	6	-
PK245-03BA	Unipolar	0.32	45	0.4	12	30	25				

How to read specifications table → Page C-11

Wirings and connections → Page C-211

● Enter **A** (single shaft) or **B** (double shaft) in the box (□) within the model name.

Dimensions Unit = mm (in.)

Model	L1	L2	Mass kg (lb.)	DXF
PK243-0□AA	33 (1.30)	-	0.21 (0.46)	B081U
PK243-0□BA		48 (1.89)		
PK244-0□AA	39 (1.54)	-	0.27 (0.59)	B082U
PK244-0□BA		54 (2.13)		
PK245-0□AA	47 (1.85)	-	0.35 (0.77)	B083U
PK245-0□BA		62 (2.44)		

● Enter the winding specification in the box (□) within the model name.

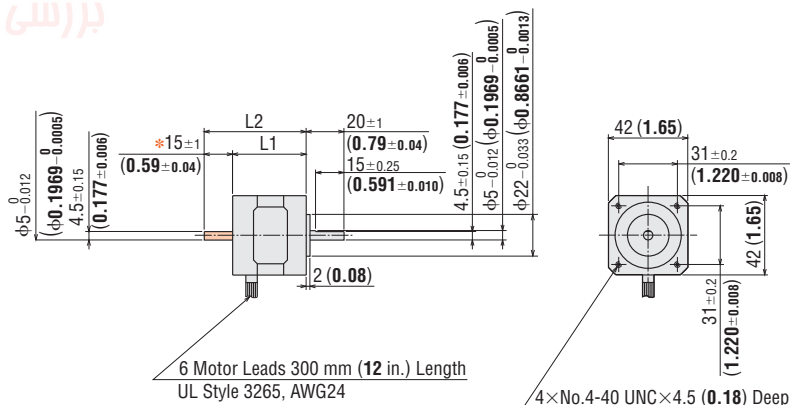

* The length of machining on the double shaft model is 15±0.25 (0.591±0.010).

● These dimensions are for the double shaft models. For the single shaft models, ignore the orange (■) area.

Speed – Torque Characteristics

How to read speed – torque characteristics → Page C-12

PK243-01BA Bipolar (Series)

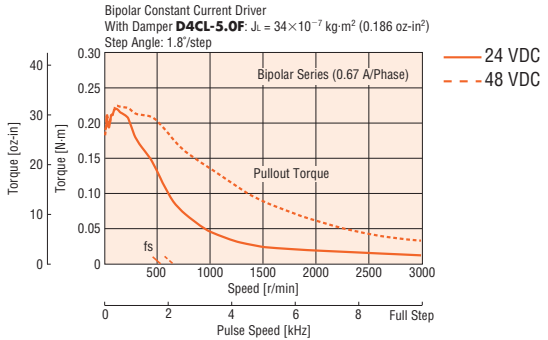

PK243-01BA Unipolar

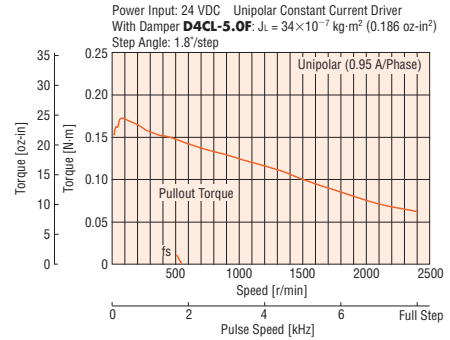

PK243-02BA Bipolar (Series)

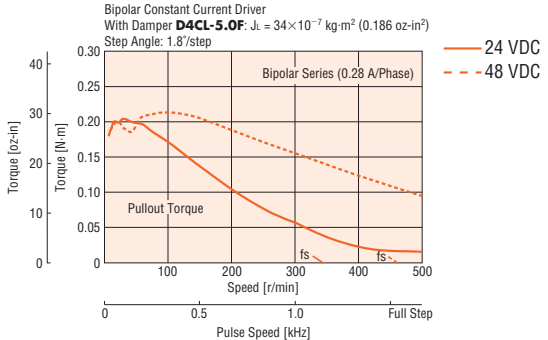

PK243-02BA Unipolar

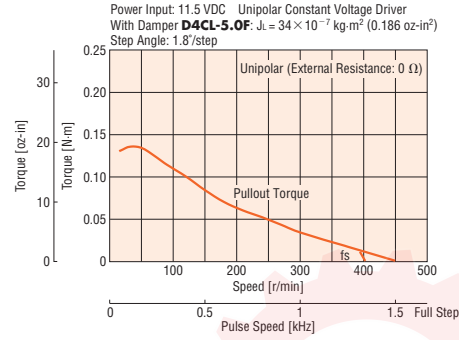

PK243-03BA Bipolar (Series)

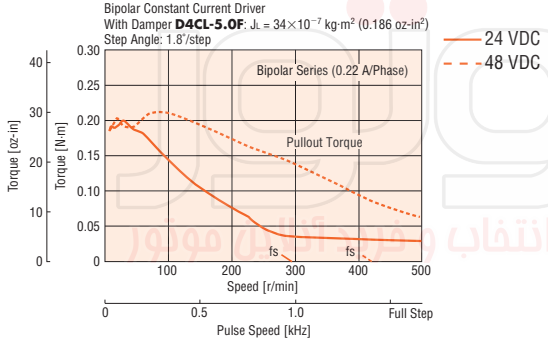

PK243-03BA Unipolar

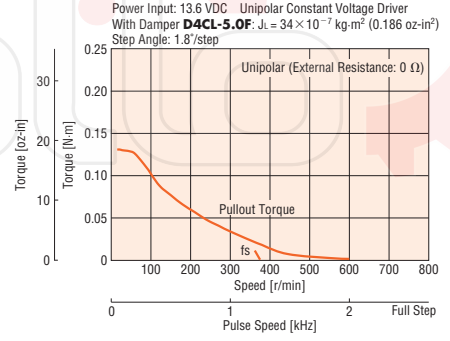

Note:

- Pay attention to heat dissipation from motor as there will be a considerable amount of heat under certain conditions. Be sure to keep the temperature of the motor case under 100°C (212°F).

- Introduction
- AC Input *QSTEP AS*
- DC Input *QSTEP ASG*
- AC Input 5-Phase Microstep *RK*
- AC Input 2-Phase Full/Half *UMK*
- AC Input 5-Phase Microstep *CMK*
- DC Input 2-Phase Microstep *RBK*
- DC Input 2-Phase Microstep *CMK*
- Without Encoder 2-Phase *PK/PV*
- With Encoder 2-Phase *PK*
- Controllers *EMP400*
- Controllers *SG8030J*
- Accessories
- Installation

□ 28 mm
(□ 1.10 in.)□ 35 mm
(□ 1.38 in.)□ 42 mm
(□ 1.65 in.)□ 50 mm
(□ 1.97 in.)□ 56.4 mm
(□ 2.22 in.)□ 60 mm
(□ 2.36 in.)□ 85 mm
(□ 3.35 in.)□ 90 mm
(□ 3.54 in.)

Speed – Torque Characteristics

How to read speed – torque characteristics → Page C-12

PK244-01BA Bipolar (Series)

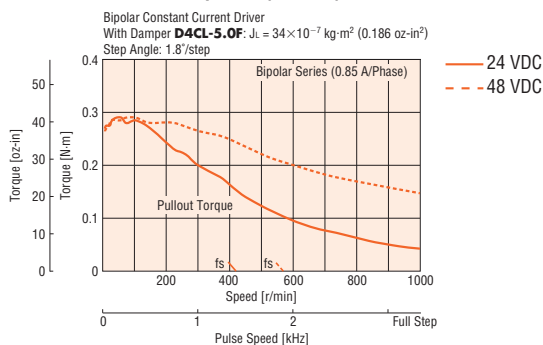

PK244-01BA Unipolar

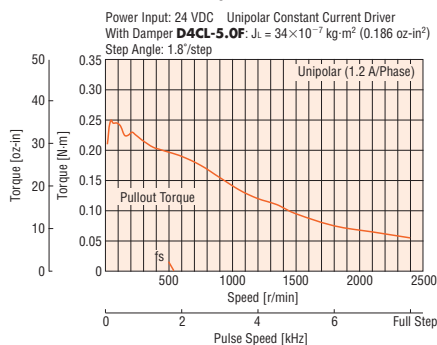

PK244-02BA Bipolar (Series)

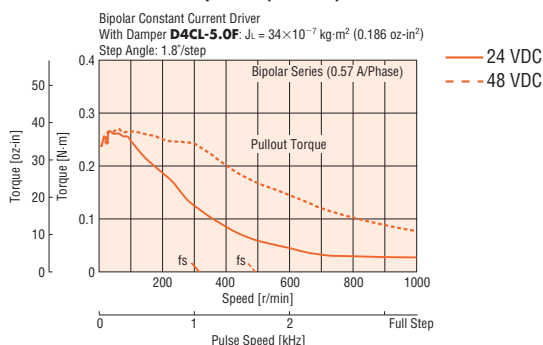

PK244-02BA Unipolar

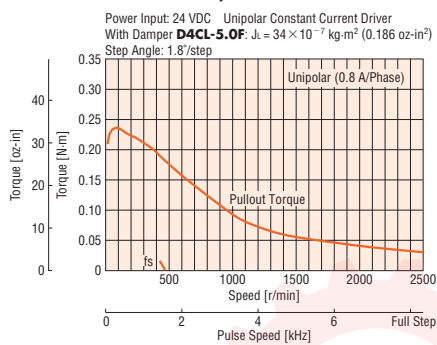

PK244-03BA Unipolar

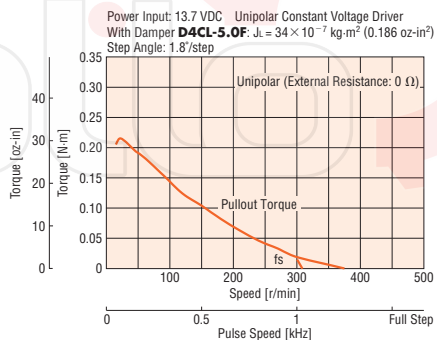

PK244-04BA Unipolar

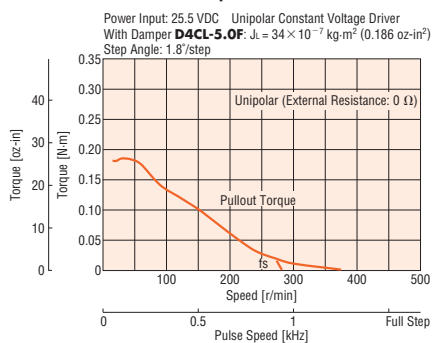

Note:

- Pay attention to heat dissipation from motor as there will be a considerable amount of heat under certain conditions. Be sure to keep the temperature of the motor case under 100°C (212°F).

موتور
بررسی، انتخاب و خرید آنلاین موتور

PK245-01BA Bipolar (Series)

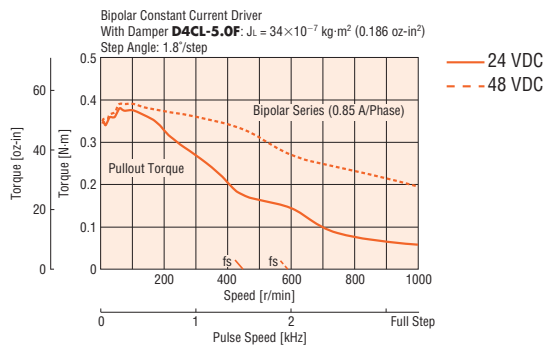

PK245-01BA Unipolar

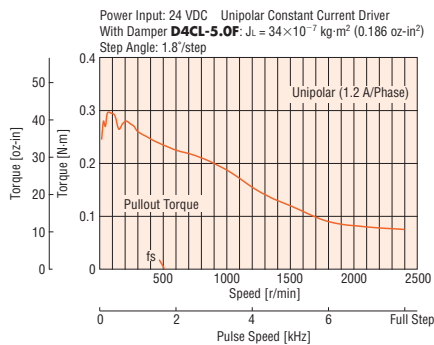

PK245-02BA Bipolar (Series)

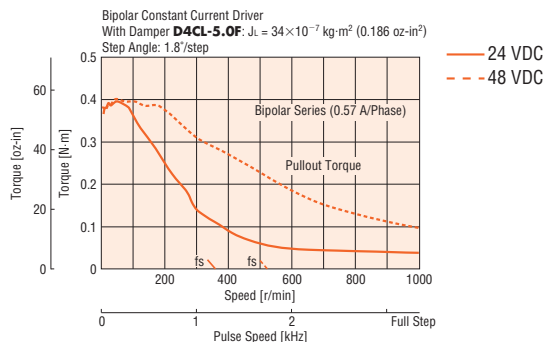

PK245-02BA Unipolar

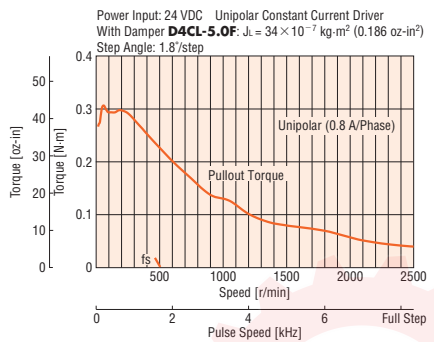

PK245-03BA Unipolar

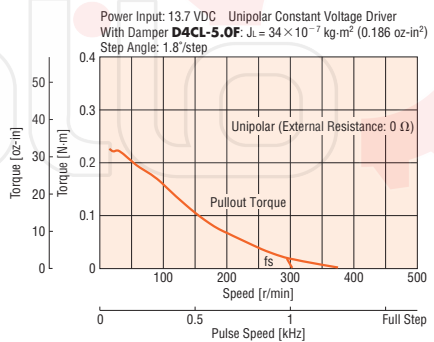

Note:

- Pay attention to heat dissipation from motor as there will be a considerable amount of heat under certain conditions. Be sure to keep the temperature of the motor case under 100°C (212°F).



42 mm (1.65 in.)

Step Angle 0.9°

PK Series High-Resolution Type



Specifications RoHS

Model	Connection Type	Holding Torque		Rated Current	Voltage	Resistance	Inductance	Rotor Inertia J		Lead Wires	Corresponding AC/DC-Input Motor & Driver Package
		N-m	oz-in					kg-m ²	oz-in ²		
PK243M-01AA PK243M-01BA	Bipolar (Series)	0.2	28	0.67	5.6	8.4	15.2	35×10 ⁻⁷	0.191	6	UMK243M□A/ CMK243M□PA
	Unipolar	0.16	22	0.95	4	4.2	3.8				
PK243M-02AA PK243M-02BA	Bipolar (Series)	0.2	28	0.42	8.4	20	38.8	35×10 ⁻⁷	0.191	6	-
	Unipolar	0.16	22	0.6	6	10	9.7				
PK243M-03AA PK243M-03BA	Bipolar (Series)	0.2	28	0.22	17	77	136	35×10 ⁻⁷	0.191	6	-
	Unipolar	0.16	22	0.31	12	38.5	34				
PK244M-01AA PK244M-01BA	Bipolar (Series)	0.31	44	0.85	5.6	6.6	17.2	54×10 ⁻⁷	0.3	6	UMK244M□A/ CMK244M□PA
	Unipolar	0.26	36	1.2	4	3.3	4.3				
PK244M-02AA PK244M-02BA	Bipolar (Series)	0.31	44	0.57	8.6	15	38.8	54×10 ⁻⁷	0.3	6	-
	Unipolar	0.26	36	0.8	6	7.5	9.7				
PK244M-03AA PK244M-03BA	Bipolar (Series)	0.31	44	0.28	17	60	152	54×10 ⁻⁷	0.3	6	-
	Unipolar	0.26	36	0.4	12	30	38				
PK245M-01AA PK245M-01BA	Bipolar (Series)	0.38	53	0.85	5.6	6.6	15.6	68×10 ⁻⁷	0.37	6	-
	Unipolar	0.32	45	1.2	4	3.3	3.9				
PK245M-02AA PK245M-02BA	Bipolar (Series)	0.38	53	0.57	8.6	15	39.6	68×10 ⁻⁷	0.37	6	UMK245M□A/ CMK245M□PA
	Unipolar	0.32	45	0.8	6	7.5	9.9				
PK245M-03AA PK245M-03BA	Bipolar (Series)	0.38	53	0.28	17	60	128	68×10 ⁻⁷	0.37	6	-
	Unipolar	0.32	45	0.4	12	30	32				

How to read specifications table → Page C-11

Wirings and connections → Page C-211

● Enter **A** (single shaft) or **B** (double shaft) in the box (□) within the model name.

Dimensions Unit = mm (in.)

Model	L1	L2	Mass kg (lb.)	DXF
PK243M-0□AA PK243M-0□BA	33 (1.30)	- 48 (1.89)	0.24 (0.53)	B081U
PK244M-0□AA PK244M-0□BA	39 (1.54)	- 54 (2.13)	0.3 (0.66)	B082U
PK245M-0□AA PK245M-0□BA	47 (1.85)	- 62 (2.44)	0.37 (0.81)	B083U

● Enter the winding specification in the box (□) within the model name.

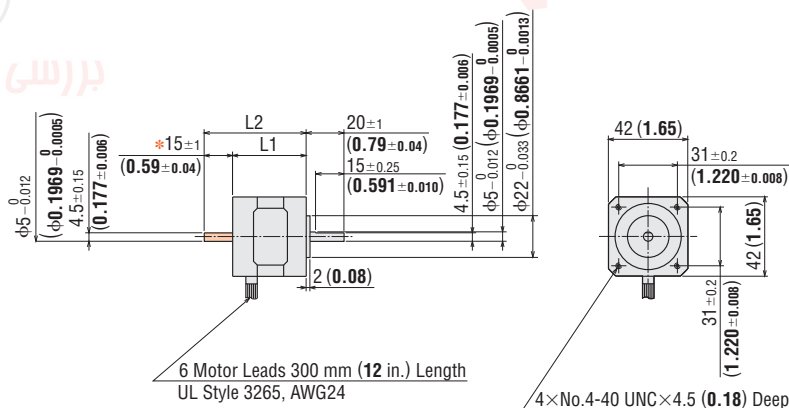

* The length of machining on the double shaft model is 15±0.25 (0.591±0.010).

● These dimensions are for the double shaft models. For the single shaft models, ignore the orange (■) area.

Speed – Torque Characteristics

How to read speed – torque characteristics → Page C-12

PK243M-01BA Bipolar (Series)

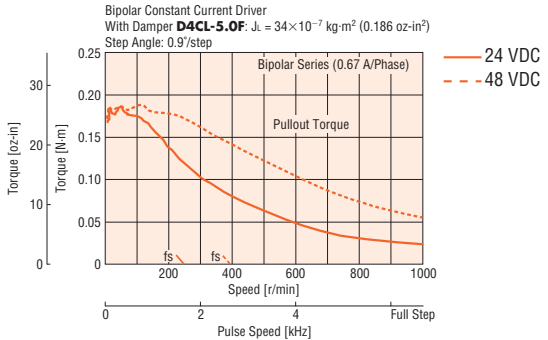

PK243M-01BA Unipolar

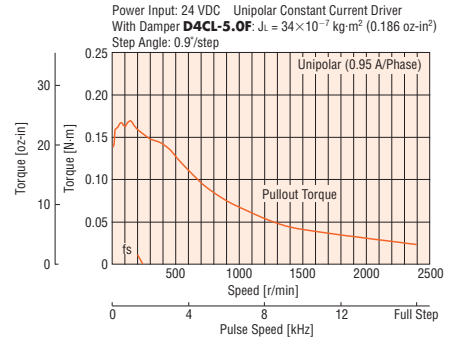

PK243M-02BA Bipolar (Series)

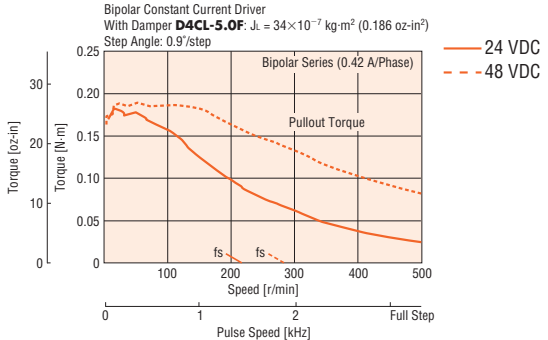

PK243M-02BA Unipolar

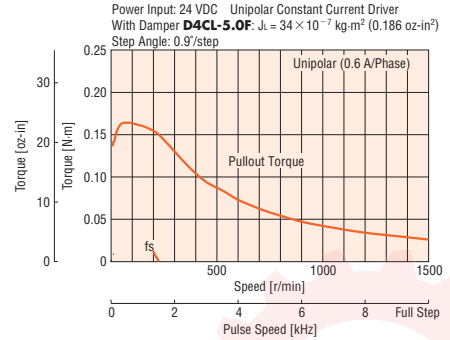

PK243M-03BA Bipolar (Series)

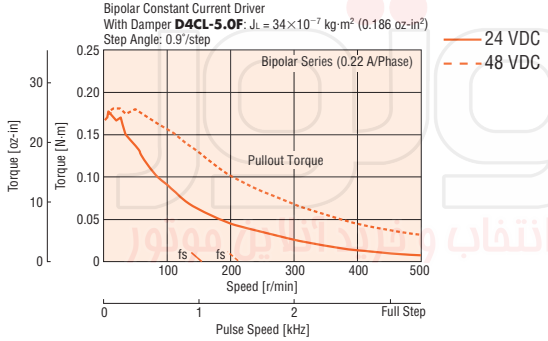

PK243M-03BA Unipolar

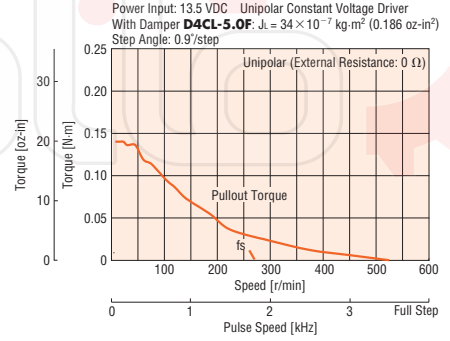

Note:

- Pay attention to heat dissipation from motor as there will be a considerable amount of heat under certain conditions. Be sure to keep the temperature of the motor case under 100°C (212°F).

Introduction

AC Input

DC Input

5-Phase Microstep

2-Phase Full/Half

5-Phase Microstep

2-Phase Microstep

2-Phase Microstep

2-Phase PK/PV Without Encoder

2-Phase PK With Encoder

EMP400

5G8030J

Accessories

Installation

28 mm
(1.10 in.)35 mm
(1.38 in.)42 mm
(1.65 in.)50 mm
(1.97 in.)56.4 mm
(2.22 in.)60 mm
(2.36 in.)85 mm
(3.35 in.)90 mm
(3.54 in.)

Speed – Torque Characteristics

How to read speed – torque characteristics → Page C-12

PK244M-01BA Bipolar (Series)

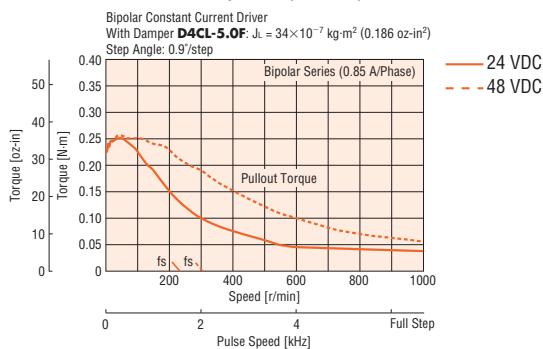

PK244M-01BA Unipolar

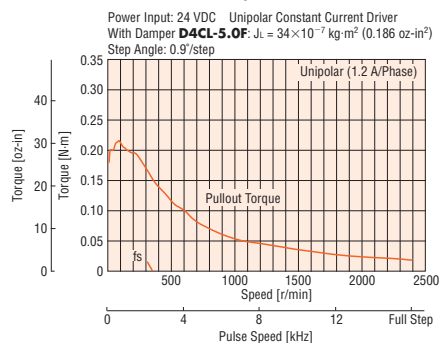

PK244M-02BA Bipolar (Series)

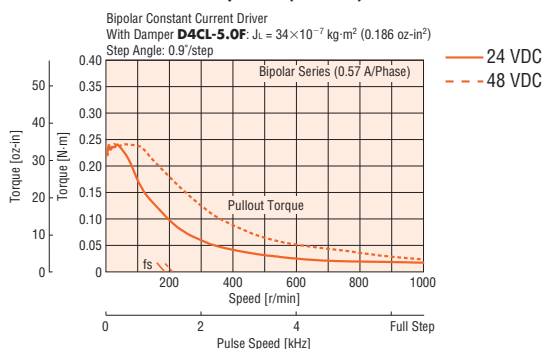

PK244M-02BA Unipolar

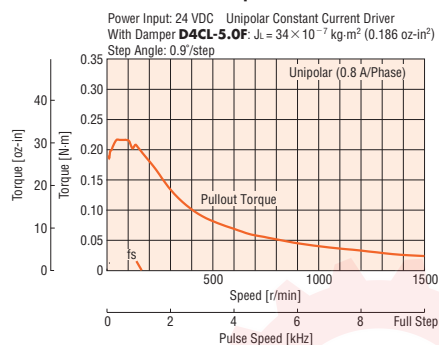

PK244M-03BA Unipolar

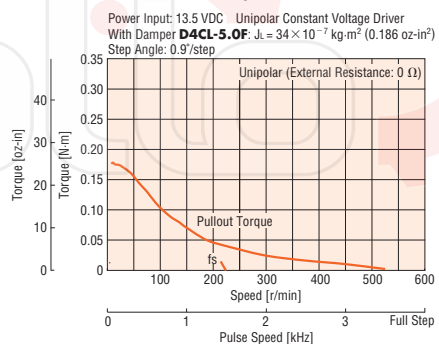

Note:

- Pay attention to heat dissipation from motor as there will be a considerable amount of heat under certain conditions. Be sure to keep the temperature of the motor case under 100°C (212°F).

موتور

بررسی، انتخاب و خرید آنلاین موتور

PK245M-01BA Bipolar (Series)

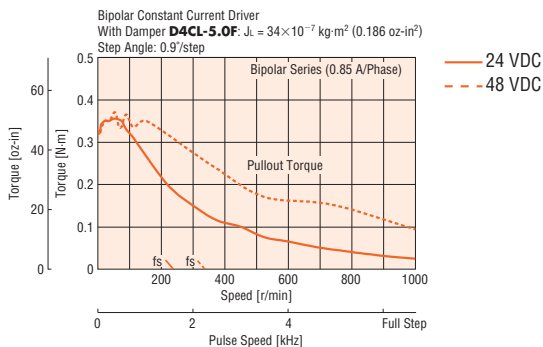

PK245M-01BA Unipolar

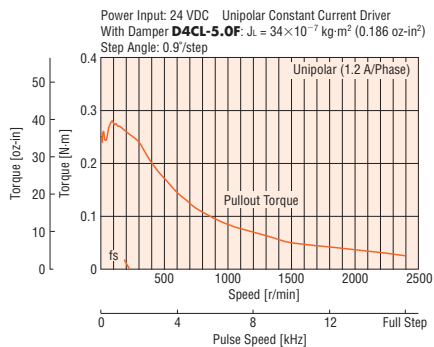

PK245M-02BA Bipolar (Series)

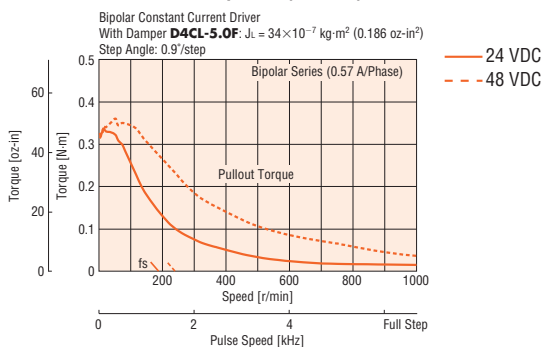

PK245M-02BA Unipolar

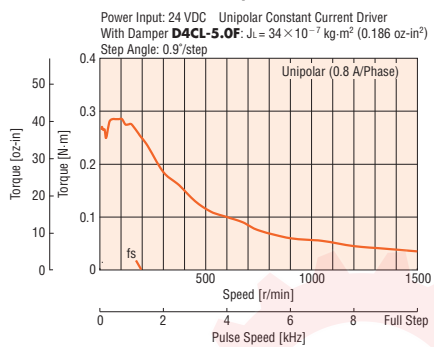

PK245M-03BA Unipolar

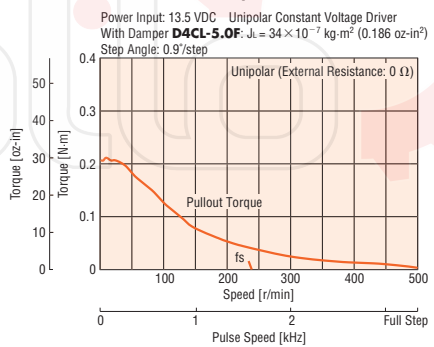

Note:

- Pay attention to heat dissipation from motor as there will be a considerable amount of heat under certain conditions. Be sure to keep the temperature of the motor case under 100°C (212°F).

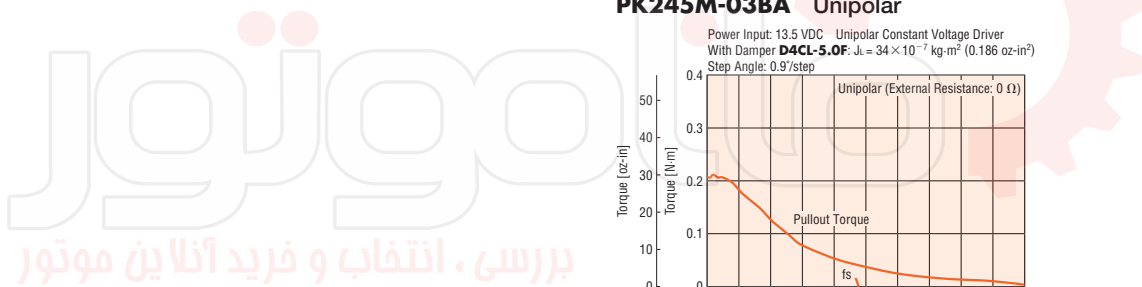

42 mm (1.65 in.)

PK Series SH Geared Type



Specifications

Motor Specifications

Model Single Shaft Double Shaft	Connection Type	Rated Current	Voltage	Resistance	Inductance	Rotor Inertia J		Lead Wires	Corresponding DC-Input Motor & Driver Package
		A/phase	VDC	Ω /phase	mH/phase	kg-m ²	oz-in ²		
PK243A1A-SG <input type="checkbox"/> PK243B1A-SG <input type="checkbox"/>	Bipolar (Series) Unipolar	0.67 0.95	5.6 4.0	8.4 4.2	10 2.5	35×10 ⁻⁷	0.191	6	CMK243 <input type="checkbox"/> PA-SG <input type="checkbox"/>
PK243A2A-SG <input type="checkbox"/> PK243B2A-SG <input type="checkbox"/>	Bipolar (Series) Unipolar	0.28 0.4	13 9.6	48 24	60 15				

How to read specifications table → Page C-11

Wirings and connections → Page C-211

- Enter **A** (single shaft) or **B** (double shaft) in the box (□) within the model name.
- Enter the gear ratio in the box (■) within the model name.

Gearmotor Specifications

Model Single Shaft Double Shaft	Gear Ratio	Holding Torque*		Step Angle	Permissible Speed r/min
		N-m	lb-in		
PK243A1A-SG3.6 , PK243A2A-SG3.6 PK243B1A-SG3.6 , PK243B2A-SG3.6	3.6:1	0.2	1.77	0.5°	500
PK243A1A-SG7.2 , PK243A2A-SG7.2 PK243B1A-SG7.2 , PK243B2A-SG7.2	7.2:1	0.4	3.5	0.25°	250
PK243A1A-SG9 , PK243A2A-SG9 PK243B1A-SG9 , PK243B2A-SG9	9:1	0.5	4.4	0.2°	200
PK243A1A-SG10 , PK243A2A-SG10 PK243B1A-SG10 , PK243B2A-SG10	10:1	0.56	4.9	0.18°	180
PK243A1A-SG18 , PK243A2A-SG18 PK243B1A-SG18 , PK243B2A-SG18	18:1	0.8	7.0	0.1°	100
PK243A1A-SG36 , PK243A2A-SG36 PK243B1A-SG36 , PK243B2A-SG36	36:1	0.8	7.0	0.05°	50

* Holding torque is the same regardless of the connection type, due to the permissible torque limit of the gearhead.

Dimensions Unit = mm (in.)

Model	Mass kg (lb.)	DXF
PK243A <input type="checkbox"/> A-SG <input type="checkbox"/>	0.35 (0.77)	B091U
PK243B <input type="checkbox"/> A-SG <input type="checkbox"/>		

- Enter the winding specification in the box (□) within the model name.
- Enter the gear ratio in the box (■) within the model name.
- Screws (Included)
No.4-40 UNC Length 10 mm (0.39 in.)...4 pieces

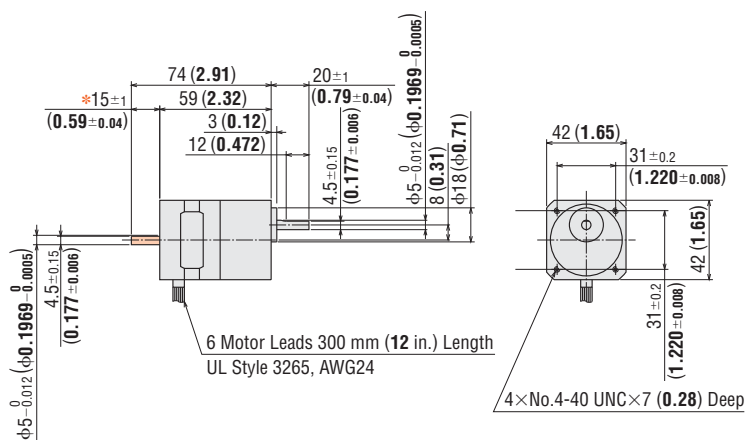

* The length of machining on the double shaft model is 15±0.25 (0.591±0.010).

● These dimensions are for the double shaft models. For the single shaft models, ignore the orange (■) area.

Speed – Torque Characteristics

How to read speed – torque characteristics → Page C-12

PK243B1A-SG Bipolar (Series) 24 VDC

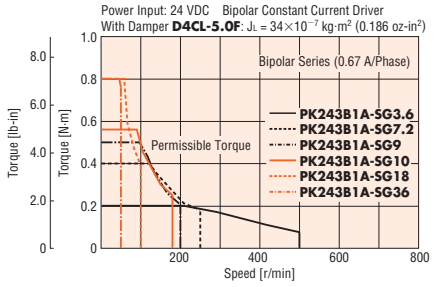

PK243B1A-SG Unipolar

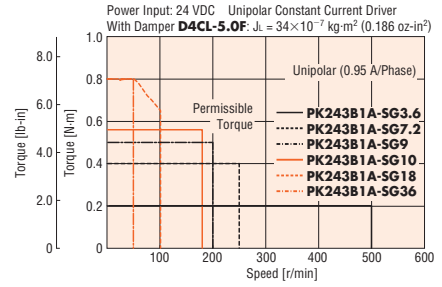

PK243B1A-SG Bipolar (Series) 48 VDC

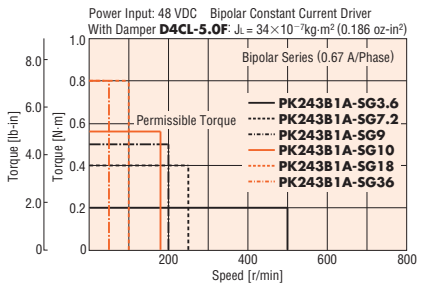

PK243B2A-SG Bipolar (Series) 24 VDC

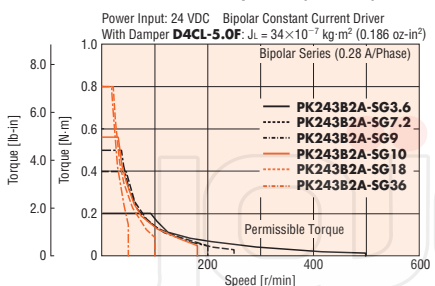

PK243B2A-SG Unipolar

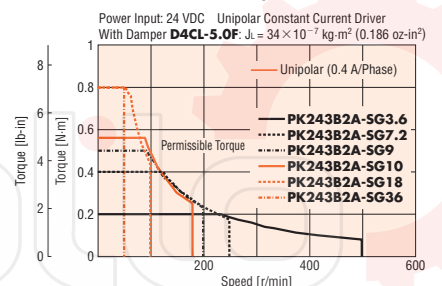

PK243B2A-SG Bipolar (Series) 48 VDC

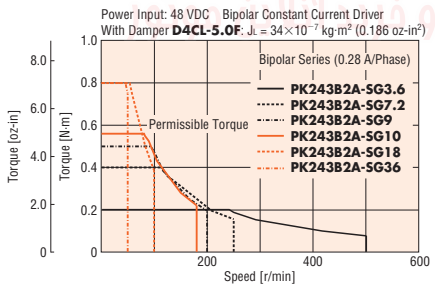

Note:

- Pay attention to heat dissipation from motor as there will be a considerable amount of heat under certain conditions. Be sure to keep the temperature of the motor case under 100°C (212°F).

- Introduction
- AC Input *QSTEP AS*
- DC Input *QSTEP ASG*
- AC Input 5-Phase Microstep *RK*
- AC Input 2-Phase Full/Half *UMK*
- DC Input 5-Phase Microstep *CMK*
- DC Input 2-Phase Microstep *RBK*
- DC Input 2-Phase Microstep *CMK*
- Without Encoder 2-Phase PK/PV
- With Encoder 2-Phase PK
- Controllers *EMP400*
- SG8030J*
- Accessories
- Installation

50 mm (1.97 in.)

Step Angle 1.8°

PK Series Standard Type

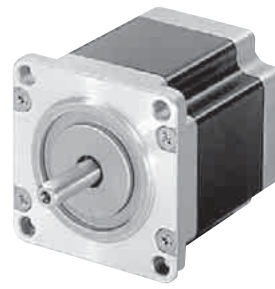

Specifications RoHS

Model	Connection Type	Holding Torque		Rated Current	Voltage	Resistance	Inductance	Rotor Inertia J		Lead Wires (Pins)	Corresponding DC-Input Motor & Driver Package
		N-m	oz-in					kg-m ²	oz-in ²		
PK256-02A	Bipolar (Series)	0.84	119	1.4	4.2	3	5.6	230×10 ⁻⁷	1.26	6	CMK256□P
PK256-02B	Unipolar	0.6	85	2	3	1.5	1.4				
PK258-02A	Bipolar (Series)	1.56	220	1.4	6.7	4.8	11.48	420×10 ⁻⁷	2.3	6	CMK258□P
PK258-02B	Unipolar	1.2	170	2	4.8	2.4	2.87				

How to read specifications table → Page C-11

Wirings and connections → Page C-211

● Enter **A** (single shaft) or **B** (double shaft) in the box (□) within the model name.

Dimensions Unit = mm (in.)

Model	L1	L2	Mass kg (lb.)	DXF
PK256-02A	51.5 (2.03)	—	0.53 (1.17)	B333
PK256-02B		67.5 (2.66)		
PK258-02A	81 (3.19)	—	0.89 (1.96)	B334
PK258-02B		97 (3.82)		

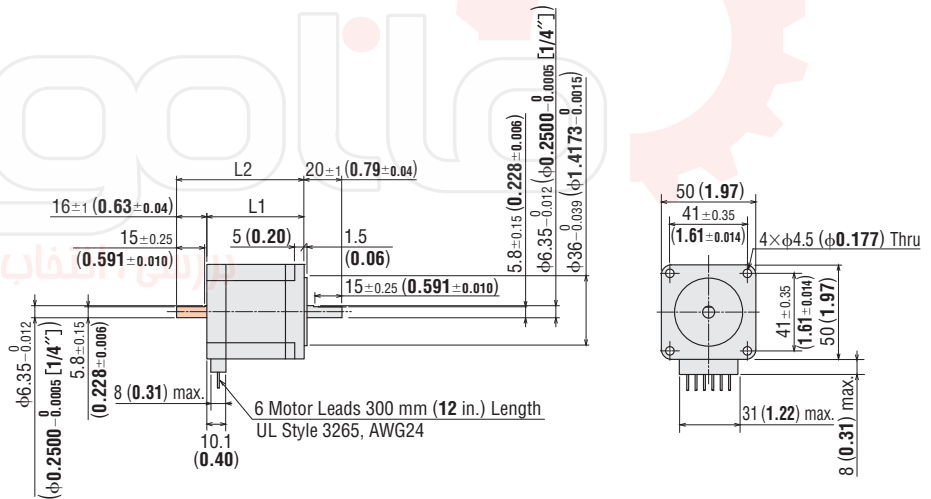

● These dimensions are for the double shaft models. For the single shaft models, ignore the orange (■) area.

Speed – Torque Characteristics

How to read speed – torque characteristics → Page C-12

PK256-02B Bipolar (Series)

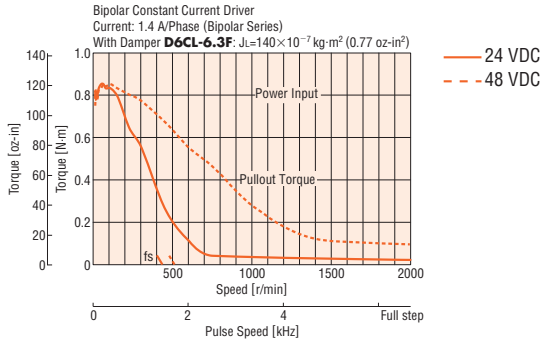

PK256-02B Unipolar

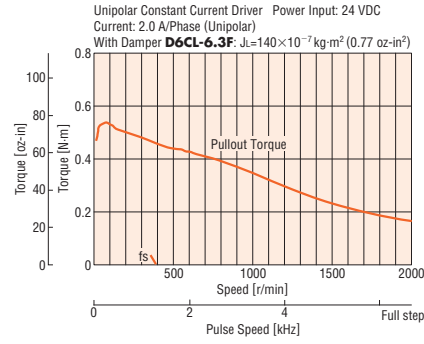

PK258-02B Bipolar (Series)

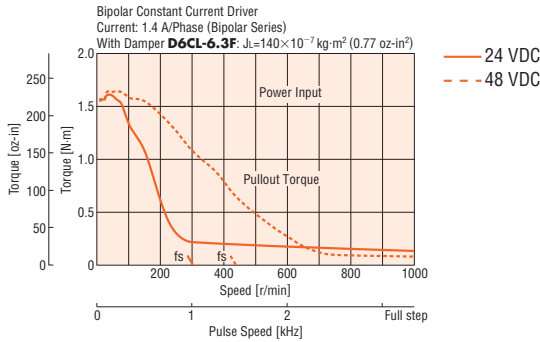

PK258-02B Unipolar

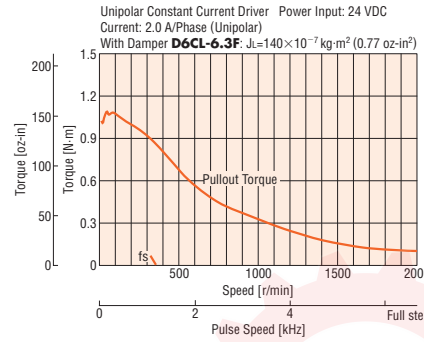

Note:

- Pay attention to heat dissipation from motor as there will be a considerable amount of heat under certain conditions. Be sure to keep the temperature of the motor case under 100°C (212°F).

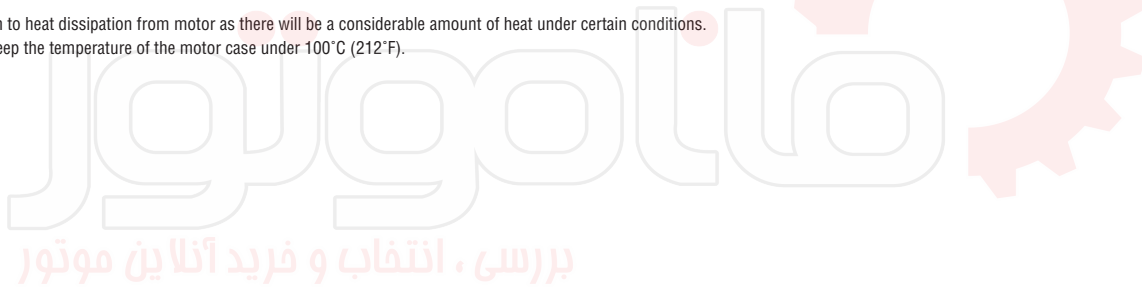

Introduction
AC Input <i>QSTEP AS</i>
DC Input <i>QSTEP ASG</i>
5-Phase Microstep <i>RK</i>
2-Phase Full/Half <i>UMK</i>
5-Phase Microstep <i>CMK</i>
2-Phase Microstep <i>RBK</i>
2-Phase Microstep <i>CMK</i>
2-Phase <i>PK/PV</i> Without Encoder
2-Phase <i>PK</i> With Encoder
EMP400 Controllers
SG8030J
Accessories
Installation

□ 56.4 mm (□ 2.22 in.)

Step Angle 1.8°

PK Series Standard Type



Specifications (RoHS)

Model	Connection Type	Holding Torque		Rated Current	Voltage	Resistance	Inductance	Rotor Inertia J		Lead Wires	Corresponding AC/DC-Input Motor & Driver Package
		N-m	oz-in					kg-m ²	oz-in ²		
PK264-0□A	Bipolar (Series)	0.48	68	0.71	8.1	11.4	21.6	120×10 ⁻⁷	0.66	6	-
PK264-0□B	Unipolar	0.39	55	1	5.7	5.7	5.4				
PK264-02A	Bipolar (Series)	0.48	68	1.4	3.9	2.8	5.6	120×10 ⁻⁷	0.66	6	UMK264□A/CMK264□P
PK264-02B	Unipolar	0.39	55	2	2.8	1.4	1.4				
PK264-03A	Bipolar (Series)	0.48	68	2.1	2.6	1.26	2.4	120×10 ⁻⁷	0.66	6	-
PK264-03B	Unipolar	0.39	55	3	1.9	0.63	0.6				
PK264-E2.0A	Bipolar (Parallel)	0.48	68	2.8	1.96	0.7	1.4	120×10 ⁻⁷	0.66	8	-
PK264-E2.0B	Bipolar (Series)	0.48	68	1.4	3.9	2.8	5.6				
PK264-E2.0B	Unipolar	0.39	55	2	2.8	1.4	1.4				
PK266-01A	Bipolar (Series)	1.17	166	0.71	11	14.8	40	300×10 ⁻⁷	1.64	6	-
PK266-01B	Unipolar	0.9	127	1	7.4	7.4	10				
PK266-02A	Bipolar (Series)	1.17	166	1.4	5	3.6	10	300×10 ⁻⁷	1.64	6	UMK266□A/CMK266□P
PK266-02B	Unipolar	0.9	127	2	3.6	1.8	2.5				
PK266-03A	Bipolar (Series)	1.17	166	2.1	3.2	1.5	4.4	300×10 ⁻⁷	1.64	6	-
PK266-03B	Unipolar	0.9	127	3	2.3	0.75	1.1				
PK266-E2.0A	Bipolar (Parallel)	1.17	166	2.8	2.52	0.9	2.5	300×10 ⁻⁷	1.64	8	-
PK266-E2.0B	Bipolar (Series)	1.17	166	1.4	5	3.6	10				
PK266-E2.0B	Unipolar	0.9	127	2	3.6	1.8	2.5				
PK268-01A	Bipolar (Series)	1.75	240	0.71	12	17.2	56	480×10 ⁻⁷	2.6	6	-
PK268-01B	Unipolar	1.35	191	1	8.6	8.6	14				
PK268-02A	Bipolar (Series)	1.75	240	1.4	6.3	4.5	14.4	480×10 ⁻⁷	2.6	6	UMK268□A/CMK268□P
PK268-02B	Unipolar	1.35	191	2	4.5	2.25	3.6				
PK268-03A	Bipolar (Series)	1.75	240	2.1	4.2	2	6.4	480×10 ⁻⁷	2.6	6	-
PK268-03B	Unipolar	1.35	191	3	3	1	1.6				
PK268-E2.0A	Bipolar (Parallel)	1.75	240	2.8	3.16	1.13	3.6	480×10 ⁻⁷	2.6	8	-
PK268-E2.0B	Bipolar (Series)	1.75	240	1.4	6.3	4.5	14.4				
PK268-E2.0B	Unipolar	1.35	191	2	4.5	2.25	3.6				

How to read specifications table → Page C-11

Wirings and connections → Page C-211

● Enter **A** (single shaft) or **B** (double shaft) in the box (□) within the model name.

Dimensions Unit = mm (in.)

Model	L1	L2	Mass kg (lb.)	DXF
PK264-0□A PK264-E2.0A	39 (1.54)	-	0.45 (0.99)	B084
PK264-0□B PK264-E2.0B		55 (2.17)		
PK266-0□A PK266-E2.0A	54 (2.13)	-	0.7 (1.54)	B085
PK266-0□B PK266-E2.0B		70 (2.76)		
PK268-0□A PK268-E2.0A	76 (2.99)	-	1 (2.2)	B086
PK268-0□B PK268-E2.0B		92 (3.62)		

● Enter the winding specification in the box (□) within the model name.

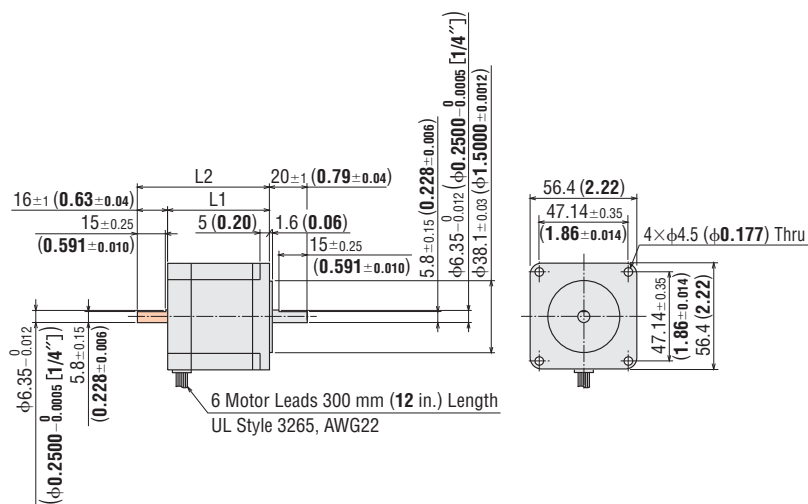

● These dimensions are for the double shaft models. For the single shaft models, ignore the orange (■) area.

Speed – Torque Characteristics

How to read speed – torque characteristics → Page C-12

PK264-01B Bipolar (Series)

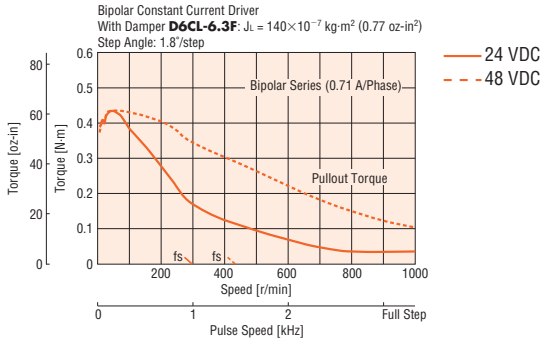

PK264-01B Unipolar

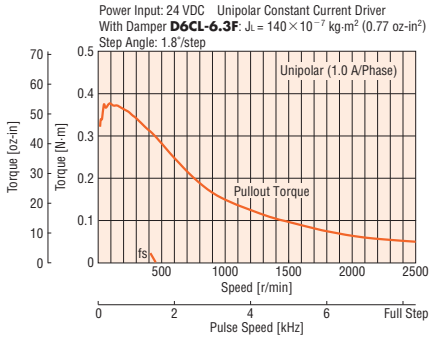

PK264-02B Bipolar (Series)

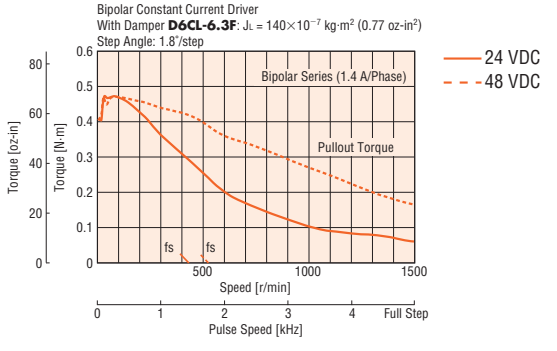

PK264-02B Unipolar

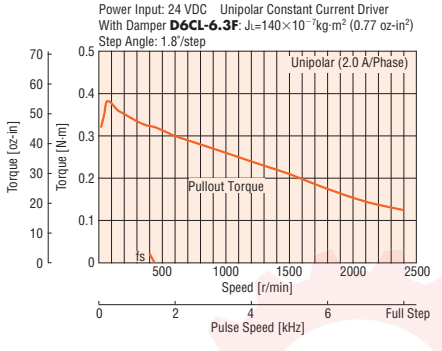

PK264-03B Bipolar (Series)

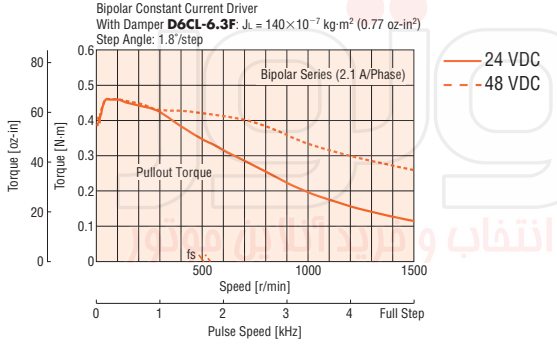

PK264-03B Unipolar

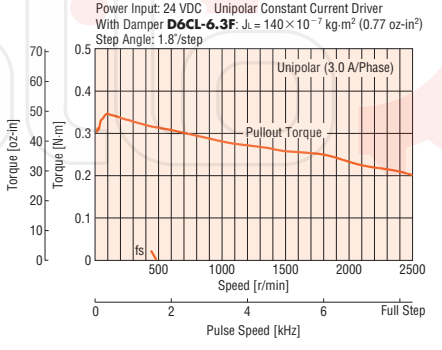

PK264-E2.0B Bipolar (Parallel)

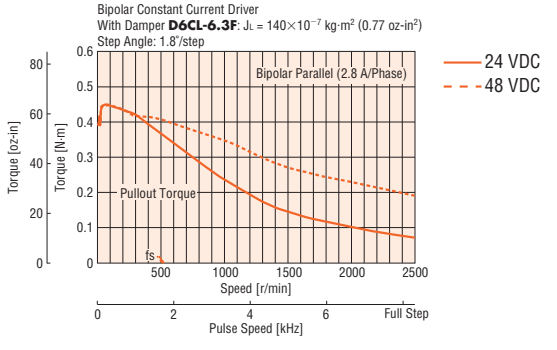

PK264-E2.0B Bipolar (Series)

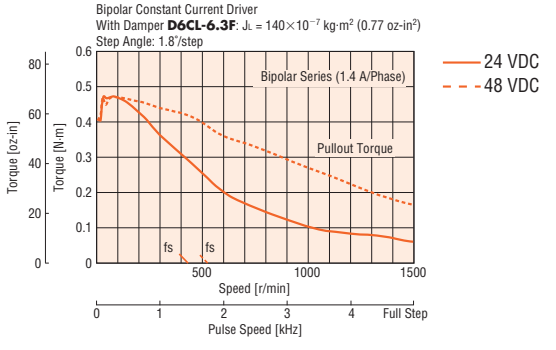

Note:

- Pay attention to heat dissipation from motor as there will be a considerable amount of heat under certain conditions. Be sure to keep the temperature of the motor case under 100°C (212°F).

Speed – Torque Characteristics

How to read speed – torque characteristics → Page C-12

PK266-01B Bipolar (Series)

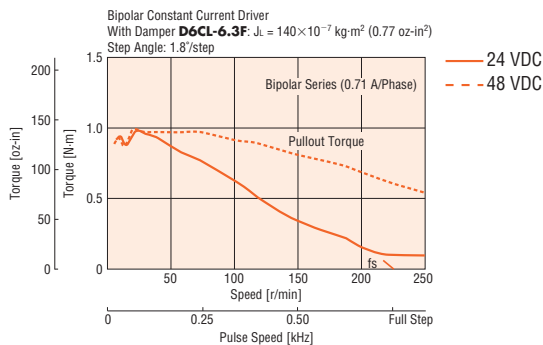

PK266-01B Unipolar

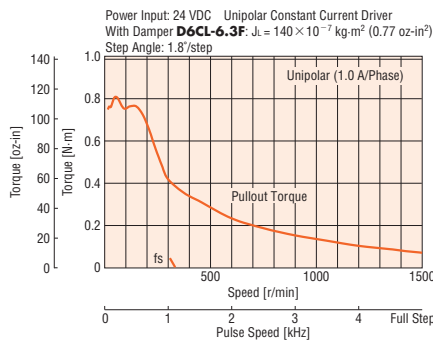

PK266-02B Bipolar (Series)

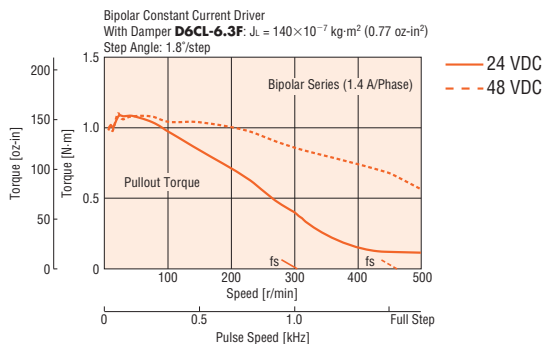

PK266-02B Unipolar

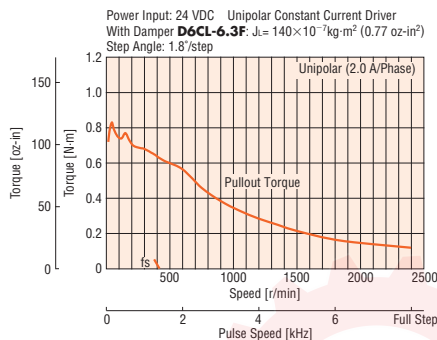

PK266-03B Bipolar (Series)

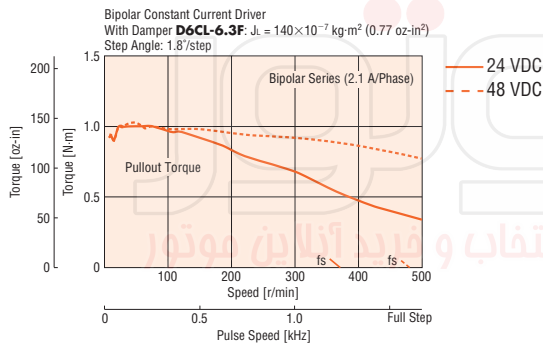

PK266-03B Unipolar

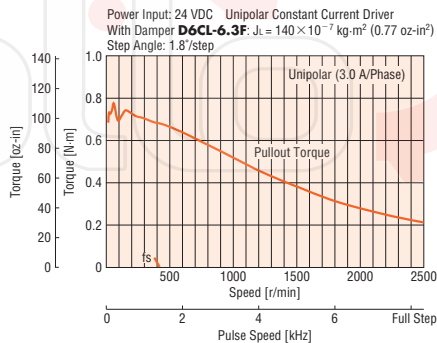

PK266-E2.0B Bipolar (Parallel)

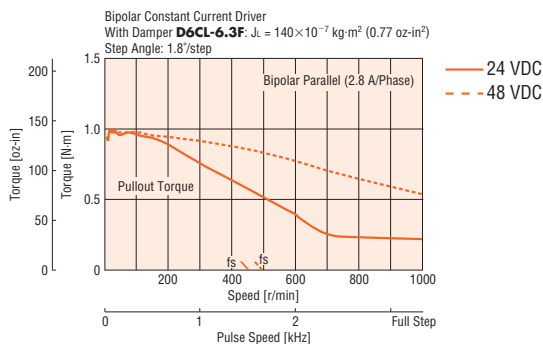

PK266-E2.0B Bipolar (Series)

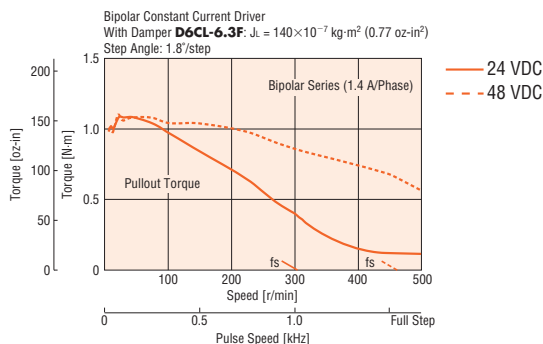

Note:

- Pay attention to heat dissipation from motor as there will be a considerable amount of heat under certain conditions. Be sure to keep the temperature of the motor case under 100°C (212°F).

PK268-01B Bipolar (Series)

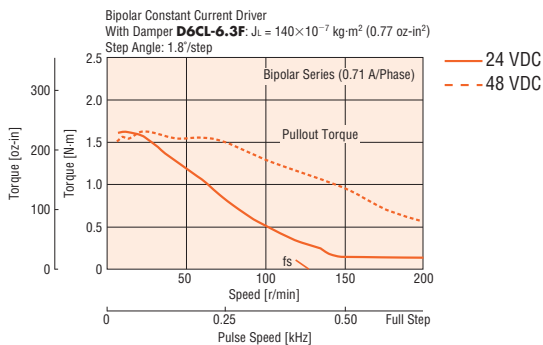

PK268-01B Unipolar

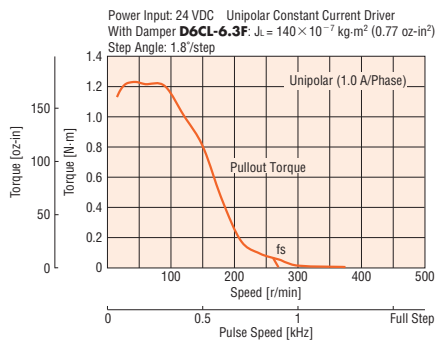

PK268-02B Bipolar (Series)

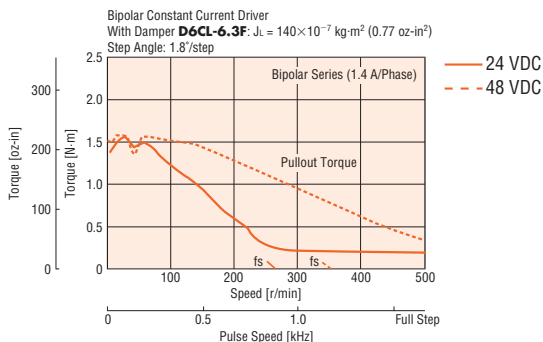

PK268-02B Unipolar

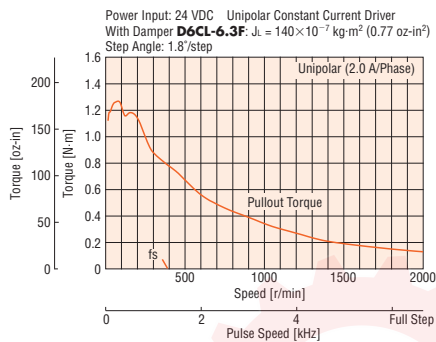

PK268-03B Bipolar (Series)

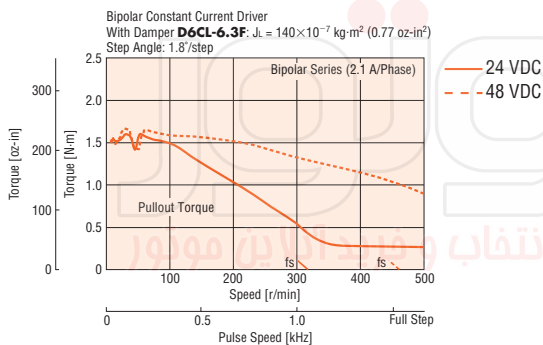

PK268-03B Unipolar

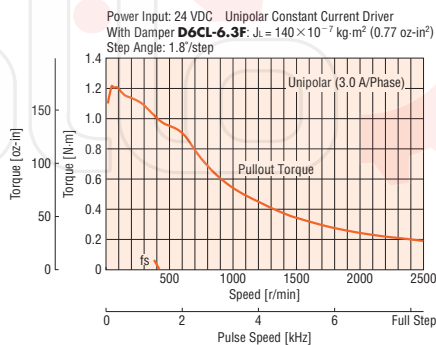

PK268-E2.0B Bipolar (Parallel)

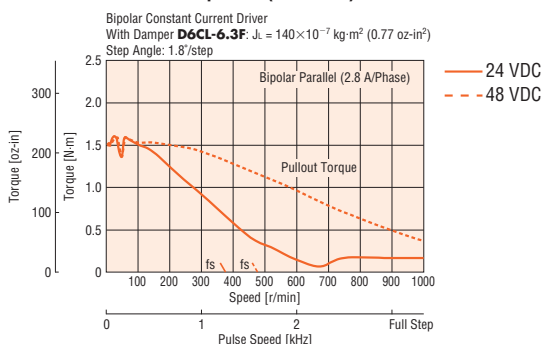

PK268-E2.0B Bipolar (Series)

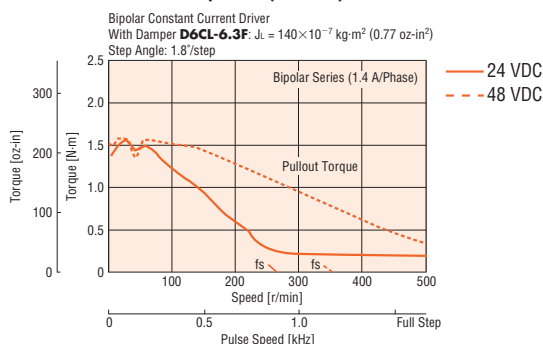

Note:

- Pay attention to heat dissipation from motor as there will be a considerable amount of heat under certain conditions. Be sure to keep the temperature of the motor case under 100°C (212°F).

□56.4 mm (□2.22 in.)

Step Angle 1.8°

PK Series Standard Type Terminal Box



■ Specifications RoHS



Model	Connection Type	Holding Torque		Rated Current	Voltage	Resistance	Inductance	Rotor Inertia J		Lead Wires (Terminals)
		N-m	oz-in					kg-m ²	oz-in ²	
Single Shaft				A/phase	VDC	Ω/phase	mH/phase			
PK264DAT	Bipolar	0.48	68	2.8	1.96	0.7	1.4	120×10 ⁻⁷	0.66	4
PK266DAT	Bipolar	1.17	166	2.8	2.52	0.9	2.5	300×10 ⁻⁷	1.64	4
PK268DAT	Bipolar	1.75	240	2.8	3.16	1.13	3.6	480×10 ⁻⁷	2.6	4

How to read specifications table → Page C-11

Wirings and connections → Page C-211

List of safety standard approved products (model, standards, file no., certification body) → Page G-11

● Degree of protection: IP65*

* Excluding the gap between the shaft and the flange.

■ Dimensions Unit = mm (in.)

Model	L	Mass kg (lb.)	DXF
PK264DAT	83 (3.27)	0.6 (1.32)	B376
PK266DAT	98 (3.86)	0.9 (1.98)	B377
PK268DAT	120 (4.72)	1.2 (2.6)	B378

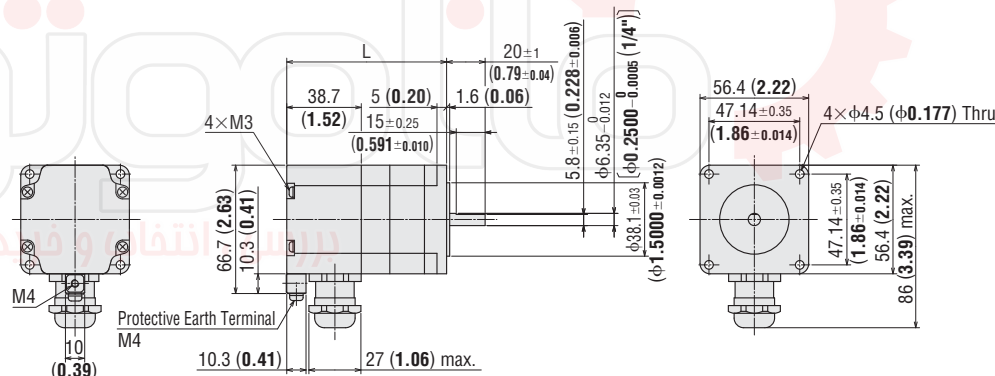

● Use cable (VCT) with a diameter of φ7~φ13 mm (φ0.28~φ0.51 in.). A motor cable is available as an accessory (sold separately). → Page C-298

Speed – Torque Characteristics

How to read speed – torque characteristics → Page C-12

PK264DAT Bipolar

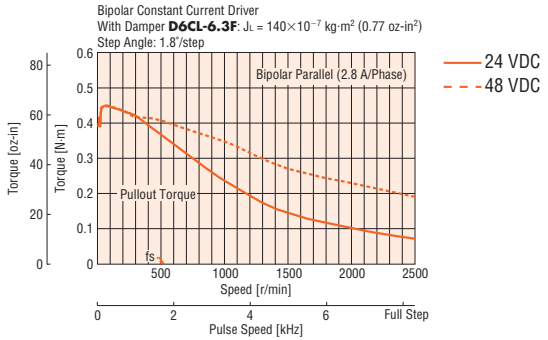

PK266DAT Bipolar

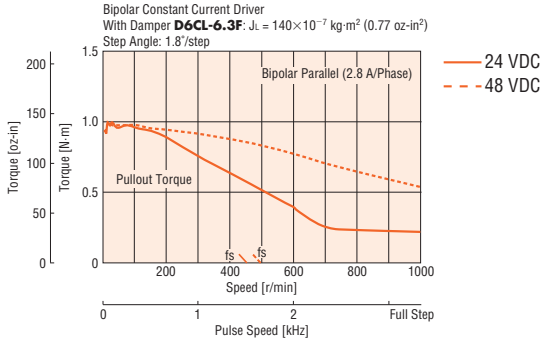

PK268DAT Bipolar

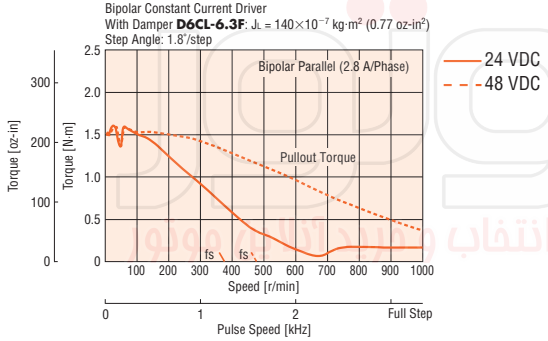

Note:

- Pay attention to heat dissipation from motor as there will be a considerable amount of heat under certain conditions. Be sure to keep the temperature of the motor case under 100°C (212°F).

- Introduction
- AC Input *QSTEP AS*
- DC Input *QSTEP ASC*
- AC Input 5-Phase Microstep *RK*
- AC Input 2-Phase Full/Half *UMK*
- DC Input 5-Phase Microstep *CMK*
- DC Input 2-Phase Microstep *RBK*
- DC Input 2-Phase Microstep *CMK*
- Without Encoder 2-Phase PK/PV
- With Encoder 2-Phase PK
- Controllers *EMP400* *SG8030J*
- Accessories
- Installation



□ 56.4 mm (□ 2.22 in.)

Step Angle 0.9°

PK Series High-Resolution Type



Specifications (RoHS)

Model	Connection Type	Holding Torque		Rated Current	Voltage	Resistance	Inductance	Rotor Inertia J		Lead Wires	Corresponding AC/DC-Input Motor & Driver Package
		N-m	oz-in					kg-m ²	oz-in ²		
PK264M-01A	Bipolar (Series)	0.48	68	0.71	8.1	11.4	26	120×10 ⁻⁷	0.66	6	-
PK264M-01B	Unipolar	0.39	55	1	5.7	5.7	6.5				
PK264M-02A	Bipolar (Series)	0.48	68	1.4	3.9	2.8	6.8	120×10 ⁻⁷	0.66	6	UMK264M□A/CMK264M□P
PK264M-02B	Unipolar	0.39	55	2	2.8	1.4	1.7				
PK264M-03A	Bipolar (Series)	0.48	68	2.1	2.6	1.26	3	120×10 ⁻⁷	0.66	6	-
PK264M-03B	Unipolar	0.39	55	3	1.9	0.63	0.75				
PK264M-E2.0A	Bipolar (Parallel)	0.48	68	2.8	1.96	0.7	1.7	120×10 ⁻⁷	0.66	8	-
PK264M-E2.0B	Bipolar (Series)	0.48	68	1.4	3.9	2.8	6.8				
PK264M-E2.0B	Unipolar	0.39	55	2	2.8	1.4	1.7				
PK266M-01A	Bipolar (Series)	1.17	166	0.71	11	14.8	50.8	300×10 ⁻⁷	1.64	6	-
PK266M-01B	Unipolar	0.9	127	1	7.4	7.4	12.7				
PK266M-02A	Bipolar (Series)	1.17	166	1.4	5	3.6	12.8	300×10 ⁻⁷	1.64	6	UMK266M□A/CMK266M□P
PK266M-02B	Unipolar	0.9	127	2	3.6	1.8	3.2				
PK266M-03A	Bipolar (Series)	1.17	166	2.1	3.2	1.5	5.8	300×10 ⁻⁷	1.64	6	-
PK266M-03B	Unipolar	0.9	127	3	2.3	0.75	1.45				
PK266M-E2.0A	Bipolar (Parallel)	1.17	166	2.8	2.52	0.9	3.2	300×10 ⁻⁷	1.64	8	-
PK266M-E2.0B	Bipolar (Series)	1.17	166	1.4	5	3.6	12.8				
PK266M-E2.0B	Unipolar	0.9	127	2	3.6	1.8	3.2				
PK268M-01A	Bipolar (Series)	1.75	240	0.71	12	17.2	77.6	480×10 ⁻⁷	2.6	6	-
PK268M-01B	Unipolar	1.35	191	1	8.6	8.6	19.4				
PK268M-02A	Bipolar (Series)	1.75	240	1.4	6.3	4.5	19.2	480×10 ⁻⁷	2.6	6	UMK268M□A/CMK268M□P
PK268M-02B	Unipolar	1.35	191	2	4.5	2.25	4.8				
PK268M-03A	Bipolar (Series)	1.75	240	2.1	4.2	2	8.4	480×10 ⁻⁷	2.6	6	-
PK268M-03B	Unipolar	1.35	191	3	3	1	2.1				
PK268M-E2.0A	Bipolar (Parallel)	1.75	240	2.8	3.16	1.13	4.8	480×10 ⁻⁷	2.6	8	-
PK268M-E2.0B	Bipolar (Series)	1.75	240	1.4	6.3	4.5	19.2				
PK268M-E2.0B	Unipolar	1.35	191	2	4.5	2.25	4.8				

How to read specifications table → Page C-11

Wirings and connections → Page C-211

● Enter **A** (single shaft) or **B** (double shaft) in the box (□) within the model name.

Dimensions Unit = mm (in.)

Model	L1	L2	Mass kg (lb.)	DXF
PK264M-0□A PK264M-E2.0A	39 (1.54)	-	0.45 (0.99)	B084
PK264M-0□B PK264M-E2.0B		55 (2.17)		
PK266M-0□A PK266M-E2.0A	54 (2.13)	-	0.7 (1.54)	B085
PK266M-0□B PK266M-E2.0B		70 (2.76)		
PK268M-0□A PK268M-E2.0A	76 (2.99)	-	1 (2.2)	B086
PK268M-0□B PK268M-E2.0B		92 (3.62)		

● Enter the winding specification in the box (□) within the model name.

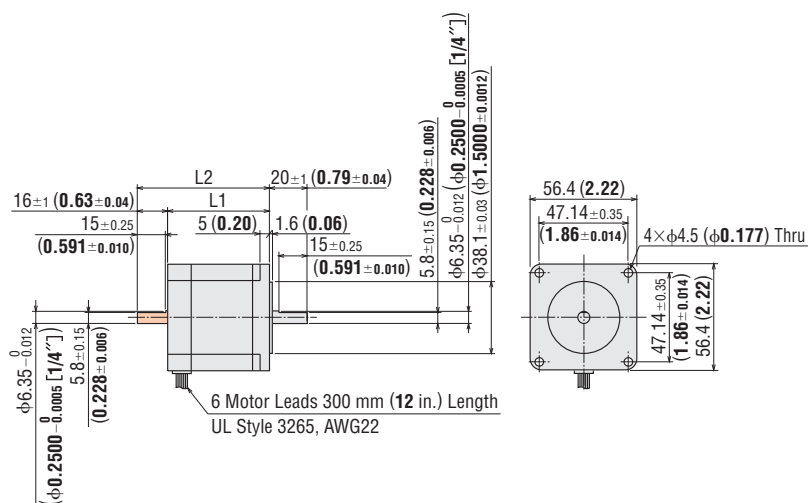

● These dimensions are for the double shaft models. For the single shaft models, ignore the orange (■) area.

Speed – Torque Characteristics

How to read speed – torque characteristics → Page C-12

PK264M-01B Bipolar (Series)

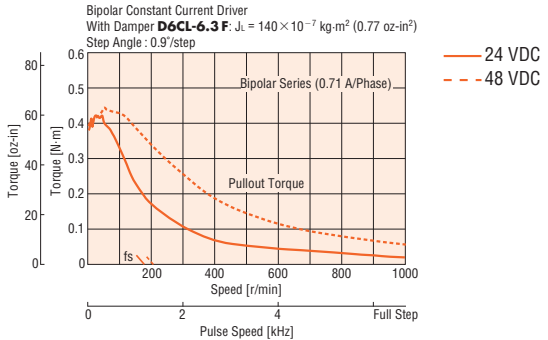

PK264M-01B Unipolar

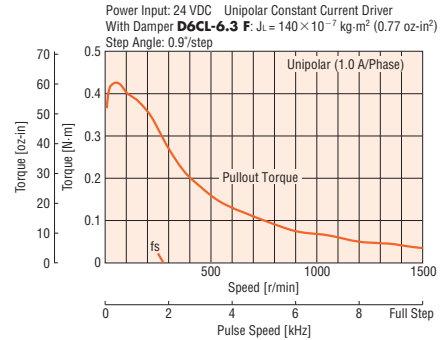

PK264M-02B Bipolar (Series)

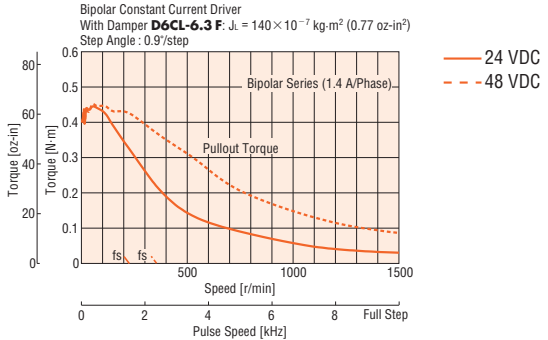

PK264M-02B Unipolar

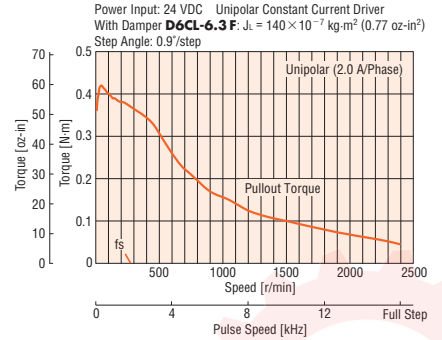

PK264M-03B Bipolar (Series)

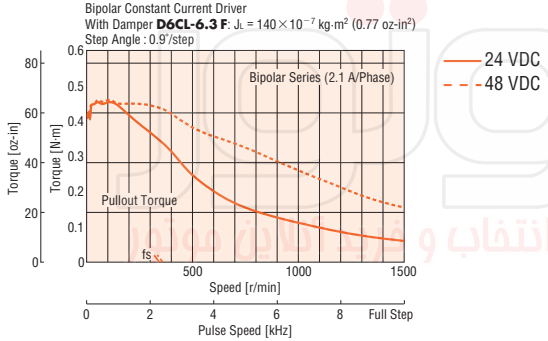

PK264M-03B Unipolar

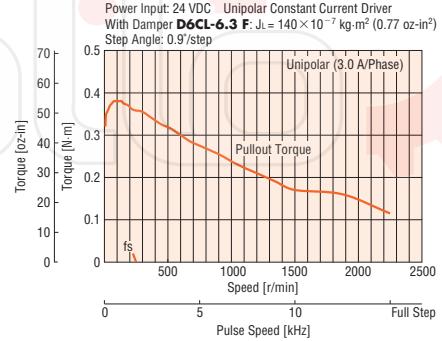

PK264M-E2.0B Bipolar (Parallel)

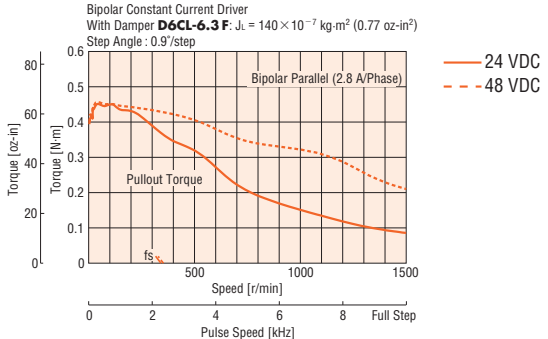

PK264M-E2.0B Bipolar (Series)

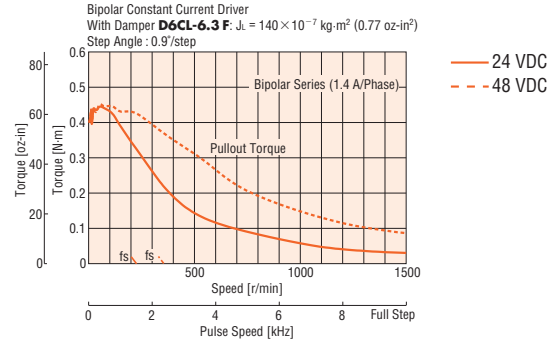

Note:

- Pay attention to heat dissipation from motor as there will be a considerable amount of heat under certain conditions. Be sure to keep the temperature of the motor case under 100°C (212°F).

Speed – Torque Characteristics

How to read speed – torque characteristics → Page C-12

PK266M-01B Bipolar (Series)

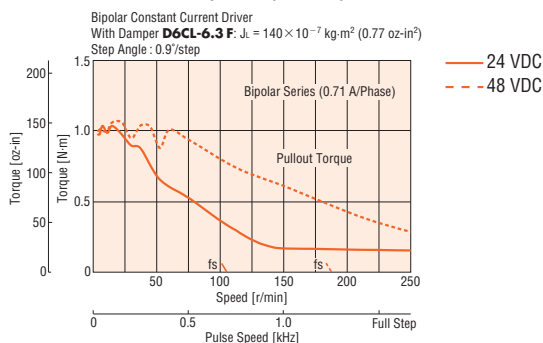

PK266M-01B Unipolar

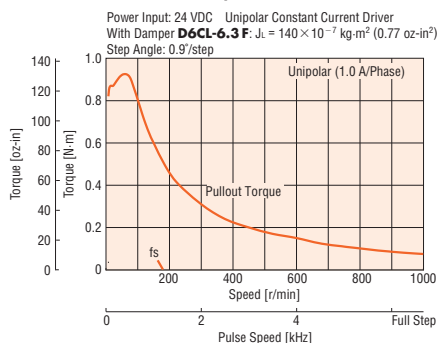

PK266M-02B Bipolar (Series)

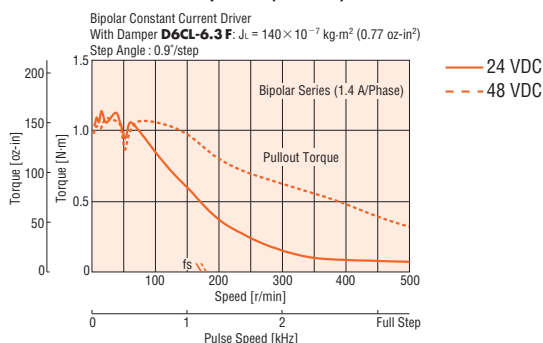

PK266M-02B Unipolar

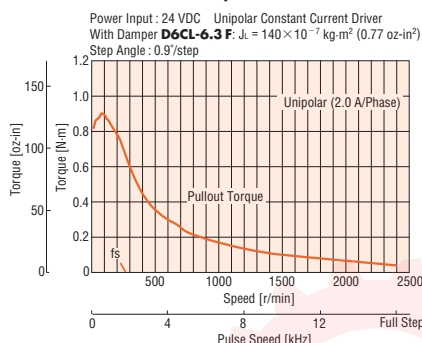

PK266M-03B Bipolar (Series)

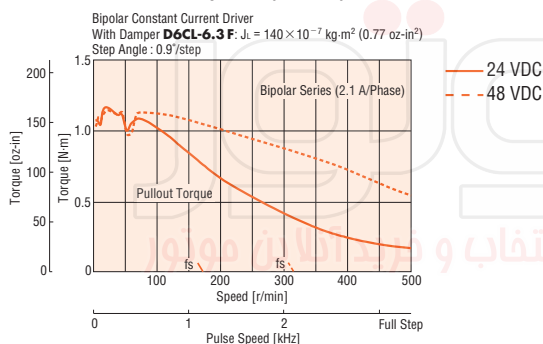

PK266M-03B Unipolar

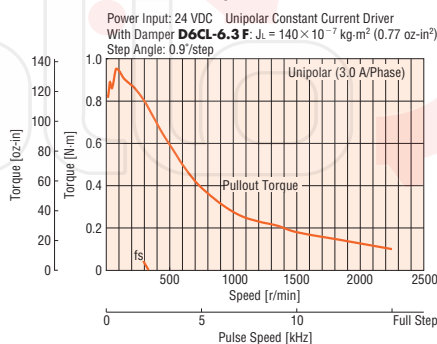

PK266M-E2.0B Bipolar (Parallel)

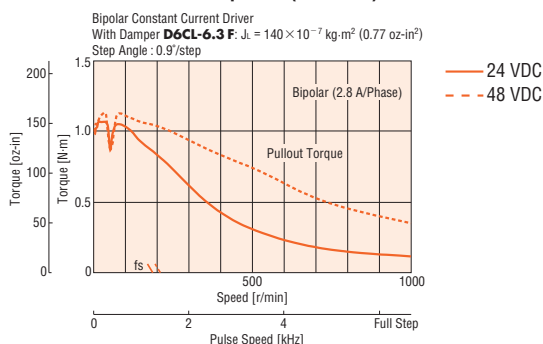

PK266M-E2.0B Bipolar (Series)

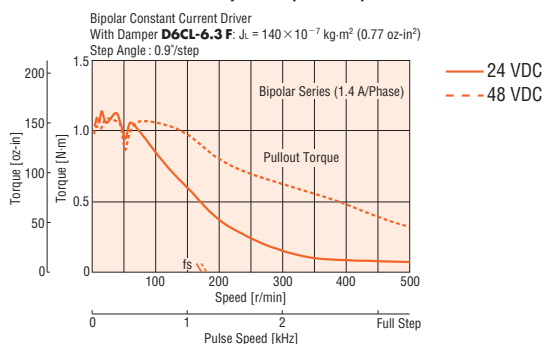

Note:

- Pay attention to heat dissipation from motor as there will be a considerable amount of heat under certain conditions. Be sure to keep the temperature of the motor case under 100°C (212°F).

PK268M-01B Bipolar (Series)

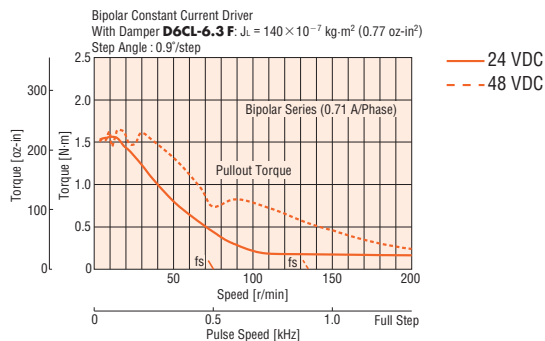

PK268M-01B Unipolar

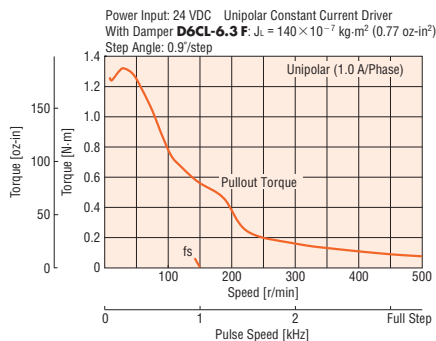

PK268M-02B Bipolar (Series)

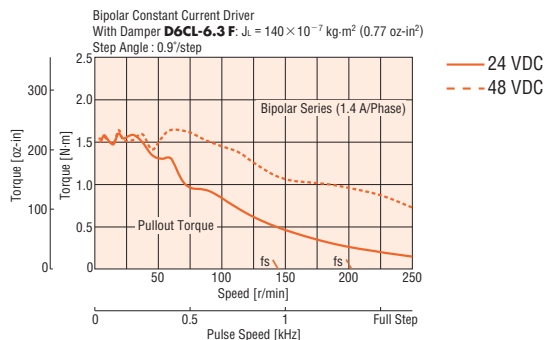

PK268M-02B Unipolar

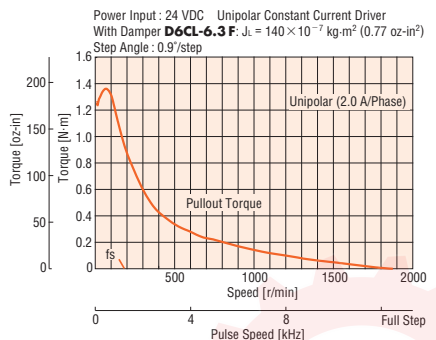

PK268M-03B Bipolar (Series)

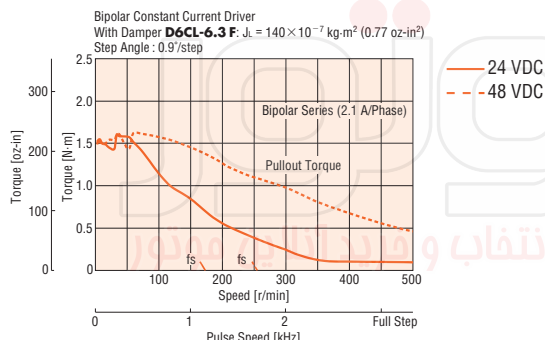

PK268M-03B Unipolar

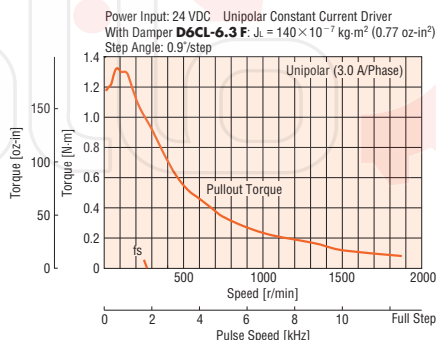

PK268M-E2.0B Bipolar (Parallel)

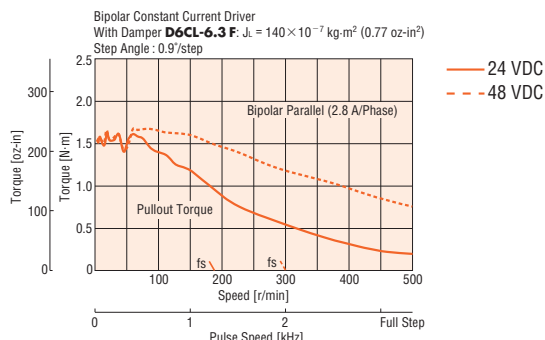

PK268M-E2.0B Bipolar (Series)

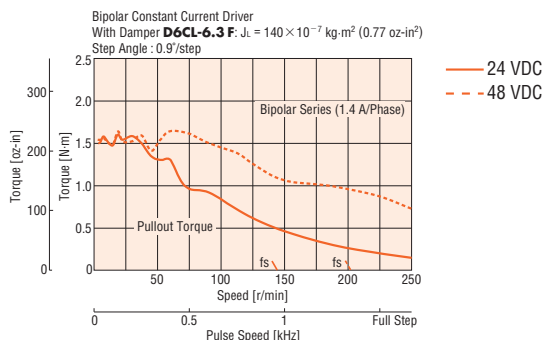

Note:

- Pay attention to heat dissipation from motor as there will be a considerable amount of heat under certain conditions. Be sure to keep the temperature of the motor case under 100°C (212°F).

60 mm (2.36 in.)

PK Series SH Geared Type



Specifications (RoHS)

Motor Specifications

Model Single Shaft Double Shaft	Connection Type	Rated Current	Voltage	Resistance	Inductance	Rotor Inertia J		Lead Wires (Pins)	Corresponding DC-Input Motor & Driver Package
		A/phase	VDC	Ω /phase	mH/phase	kg-m ²	oz-in ²		
PK264A1A-SG <input type="checkbox"/> PK264B1A-SG <input type="checkbox"/>	Bipolar (Series)	0.71	8.1	11.4	21.6	120×10^{-7}	0.66	6	-
	Unipolar	1	5.7	5.7	5.4				
PK264A2A-SG <input type="checkbox"/> PK264B2A-SG <input type="checkbox"/>	Bipolar (Series)	1.4	3.9	2.8	5.6	120×10^{-7}	0.66	6	CMK264 <input type="checkbox"/> PA-SG <input type="checkbox"/>
	Unipolar	2	2.8	1.4	1.4				

How to read specifications table → Page C-11

Wirings and connections → Page C-211

- Enter **A** (single shaft) or **B** (double shaft) in the box () within the model name.
- Enter the gear ratio in the box () within the model name.

Gearmotor Specifications

Model Single Shaft Double Shaft	Gear Ratio	Holding Torque*		Step Angle	Permissible Speed r/min
		N-m	lb-in		
PK264A1A-SG3.6 , PK264A2A-SG3.6 PK264B1A-SG3.6 , PK264B2A-SG3.6	3.6:1	1	8.8	0.5°	500
PK264A1A-SG7.2 , PK264A2A-SG7.2 PK264B1A-SG7.2 , PK264B2A-SG7.2	7.2:1	2	17.7	0.25°	250
PK264A1A-SG9 , PK264A2A-SG9 PK264B1A-SG9 , PK264B2A-SG9	9:1	2.5	22	0.2°	200
PK264A1A-SG10 , PK264A2A-SG10 PK264B1A-SG10 , PK264B2A-SG10	10:1	2.7	23	0.18°	180
PK264A1A-SG18 , PK264A2A-SG18 PK264B1A-SG18 , PK264B2A-SG18	18:1	3	26	0.1°	100
PK264A1A-SG36 , PK264A2A-SG36 PK264B1A-SG36 , PK264B2A-SG36	36:1	4	35	0.05°	50

*Holding torque is the same regardless of the connection type, due to the permissible torque limit of the gearhead.

Dimensions Unit = mm (in.)

Model	Mass kg (lb.)	DXF
PK264A <input type="checkbox"/> A-SG <input type="checkbox"/>	0.75 (1.7)	B092U
PK264B <input type="checkbox"/> A-SG <input type="checkbox"/>		

- Enter the winding specification in the box () within the model name.
- Enter the gear ratio in the box () within the model name.
- Screws (Included)
No.8-32 UNC Length 15.8 mm (0.62 in.) ···4 pieces

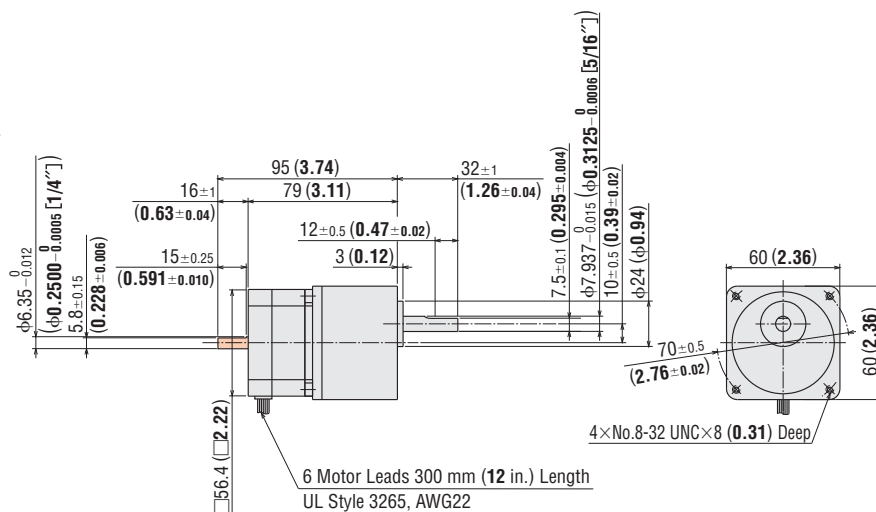

- These dimensions are for the double shaft models. For the single shaft models, ignore the orange () area.

Speed – Torque Characteristics

How to read speed – torque characteristics → Page C-12

PK264B1A-SG Bipolar (Series) 24 VDC

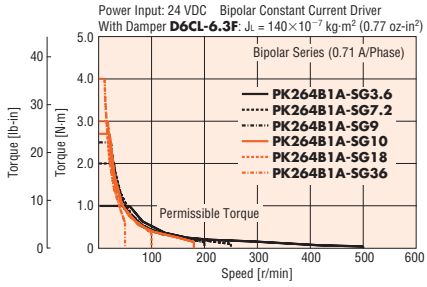

PK264B1A-SG Unipolar

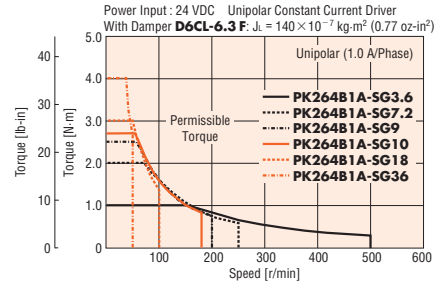

PK264B1A-SG Bipolar (Series) 48 VDC

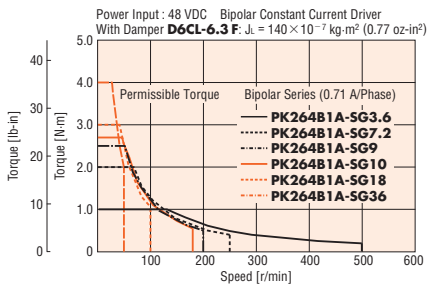

PK264B2A-SG Bipolar (Series) 24 VDC

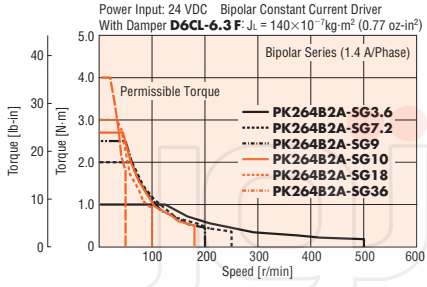

PK264B2A-SG Unipolar

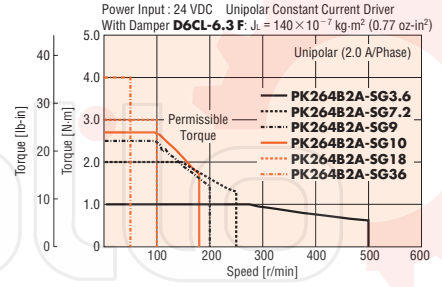

PK264B2A-SG Bipolar (Series) 48 VDC

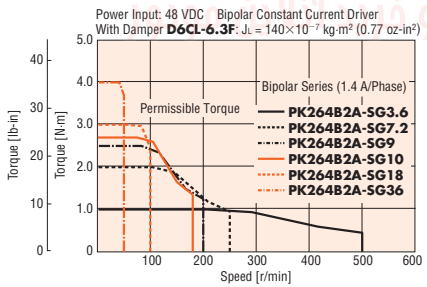

Note:

- Pay attention to heat dissipation from motor as there will be a considerable amount of heat under certain conditions. Be sure to keep the temperature of the motor case under 100°C (212°F).

- Introduction
- AC Input *QSTEP AS*
- DC Input *QSTEP ASG*
- 5-Phase Microstep *RK*
- 2-Phase Full/Half *UMK*
- 5-Phase Microstep *CMK*
- 2-Phase Microstep *RBK*
- 2-Phase Microstep *CMK*
- 2-Phase PK/PV *Without Encoder*
- 2-Phase PK *With Encoder*
- EMP400 *Controllers*
- SG8030J
- Accessories
- Installation

□ 60 mm (□ 2.36 in.)

Step Angle 1.8°

PV Series (High inertia capability)

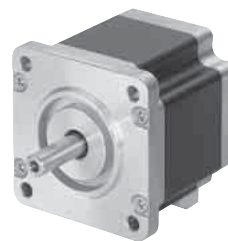

Specifications (RoHS)

Model	Connection Type	Holding Torque		Rated Current	Voltage	Resistance	Inductance	Rotor Inertia J		Lead Wires
		N-m	oz-in					kg-m ²	oz-in ²	
PV264-D2.8AA PV264-D2.8BA	Bipolar	1.06	150	2.8	2.1	0.73	1.8	280×10 ⁻⁷	1.53	4
	Bipolar (Series) Unipolar	1.06 0.75	150 106	1.4 2	4.1 2.9	2.92 1.46	7.2 1.8	280×10 ⁻⁷	1.53	6
PV266-D2.8AA PV266-D2.8BA	Bipolar	1.75	240	2.8	2.8	1	3.05	450×10 ⁻⁷	2.5	4
	Bipolar (Series) Unipolar	1.75 1.35	240 191	1.4 2	5.6 4	4 2	12.2 3.05	450×10 ⁻⁷	2.5	6
PV267-D2.8AA PV267-D2.8BA	Bipolar	2.2	310	2.8	3.4	1.2	3.54	570×10 ⁻⁷	3.1	4
	Bipolar (Series) Unipolar	2.2 1.7	310 240	1.4 2	6.7 4.8	4.8 2.4	14.2 3.54	570×10 ⁻⁷	3.1	6
PV269-D2.8AA PV269-D2.8BA	Bipolar	3.1	440	2.8	4.2	1.49	5.7	900×10 ⁻⁷	4.9	4
	Bipolar (Series) Unipolar	3.1 2.2	440 310	1.4 2	8.3 6	5.96 2.98	22.8 5.7	900×10 ⁻⁷	4.9	6

How to read specifications table → Page C-11

Wirings and connections → Page C-211

Dimensions Unit = mm (in.)

● PV264, PV266, PV267

Model	L1	L2	Mass kg (lb.)	DXF
PV264-D2.8AA PV264-D2.8BA	43.5 (1.71)	-	0.6 (1.3)	B279U
PV266-D2.8AA PV266-D2.8BA	54 (2.13)	70 (2.76)	0.83 (1.8)	B232U
PV267-D2.8AA PV267-D2.8BA	65 (2.56)	81 (3.19)	1.02 (2.2)	B813U

● PV269

Model	Mass kg (lb.)	DXF
PV269-D2.8AA PV269-D2.8BA	1.43 (3.1)	B814U

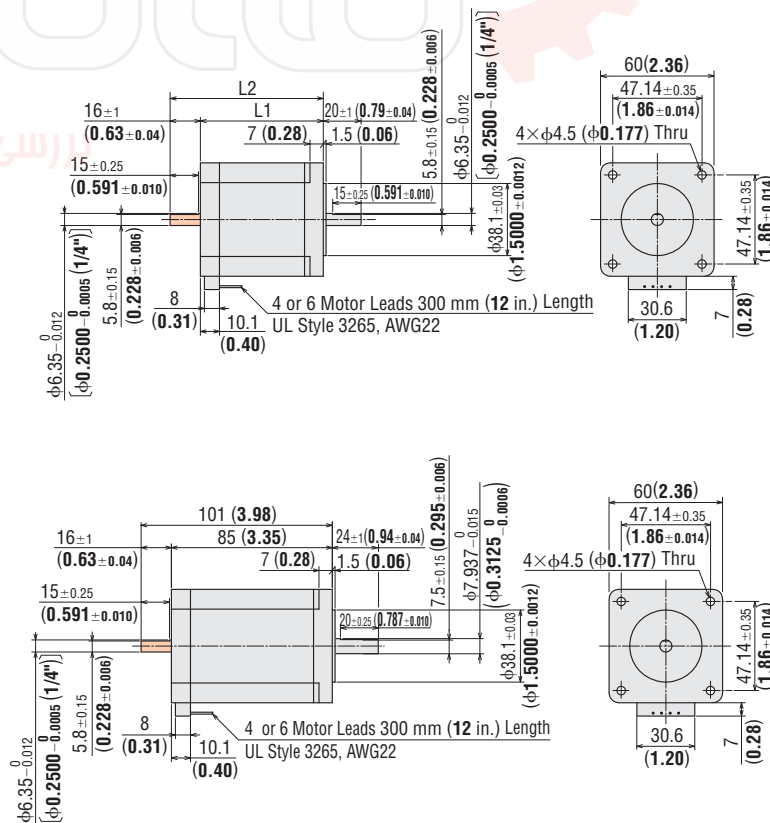

● These dimensions are for the double shaft models. For the single shaft models, ignore the orange () areas.

Speed – Torque Characteristics

How to read speed – torque characteristics → Page C-12

PV264-D2.8BA Bipolar

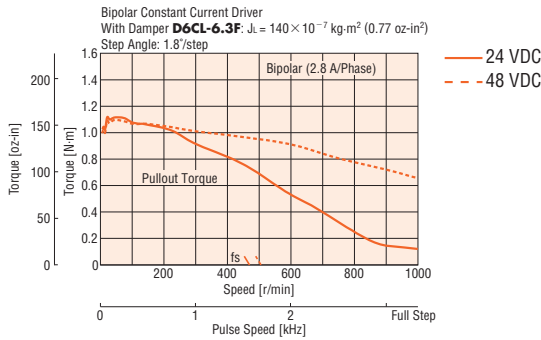

PV266-D2.8BA Bipolar

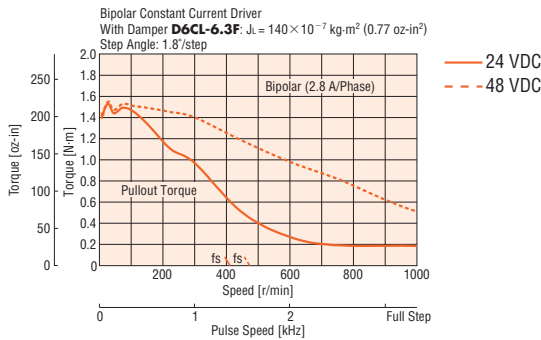

PV267-D2.8BA Bipolar

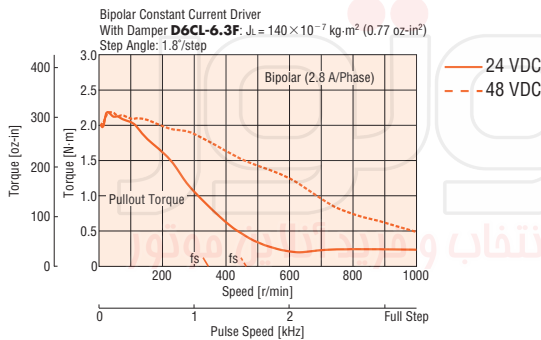

PV269-D2.8BA Bipolar

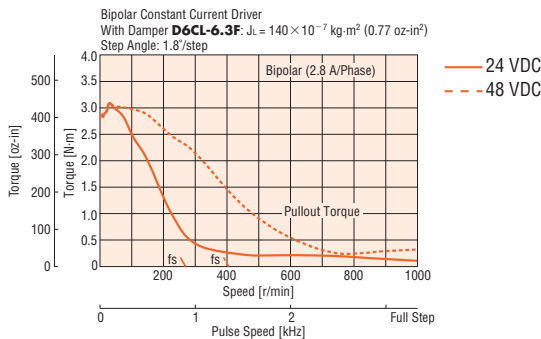

Note:

- Pay attention to heat dissipation from motor as there will be a considerable amount of heat under certain conditions. Be sure to keep the temperature of the motor case under 100°C (212°F).

- Introduction
- AC Input *QSTEP AS*
- DC Input *QSTEP ASC*
- AC Input 5-Phase Microstep *RK*
- AC Input 2-Phase Full/Half *UMK*
- DC Input 5-Phase Microstep *CMK*
- DC Input 2-Phase Microstep *RBK*
- DC Input 2-Phase Microstep *CMK*
- Without Encoder 2-Phase *PK/PV*
- With Encoder 2-Phase *PK*
- Controllers *EMP400* *SG8030J*
- Accessories
- Installation

□ 28 mm
(□ 1.10 in.)□ 35 mm
(□ 1.38 in.)□ 42 mm
(□ 1.65 in.)□ 50 mm
(□ 1.97 in.)□ 56.4 mm
(□ 2.22 in.)□ 60 mm
(□ 2.36 in.)□ 85 mm
(□ 3.35 in.)□ 90 mm
(□ 3.54 in.)

Speed – Torque Characteristics

How to read speed – torque characteristics → Page C-12

PV264-02BA Bipolar (Series)

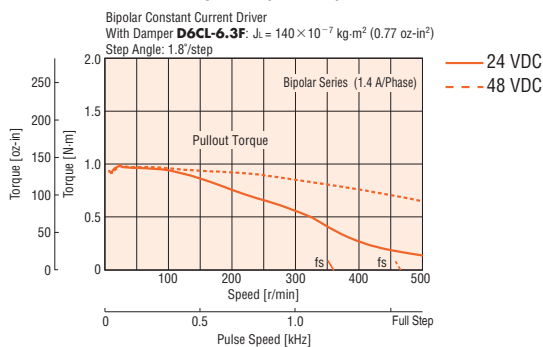

PV264-02BA Unipolar

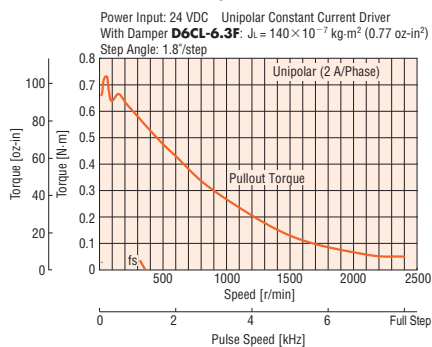

PV266-02BA Bipolar (Series)

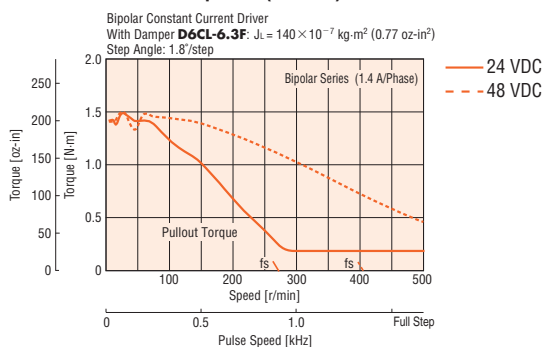

PV266-02BA Unipolar

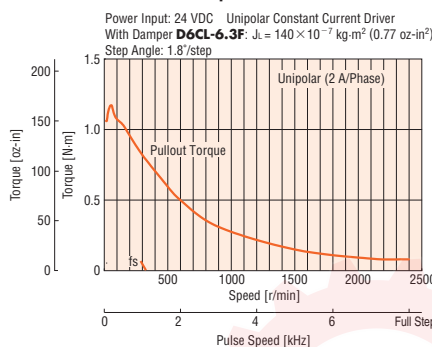

PV267-02BA Bipolar (Series)

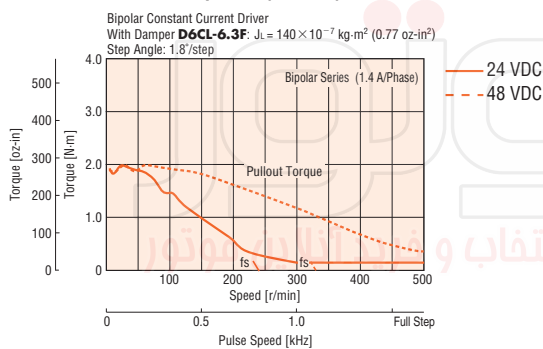

PV267-02BA Unipolar

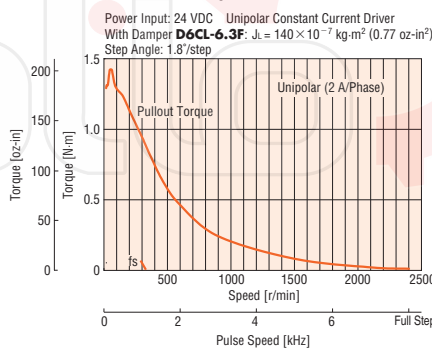

PV269-02BA Bipolar (Series)

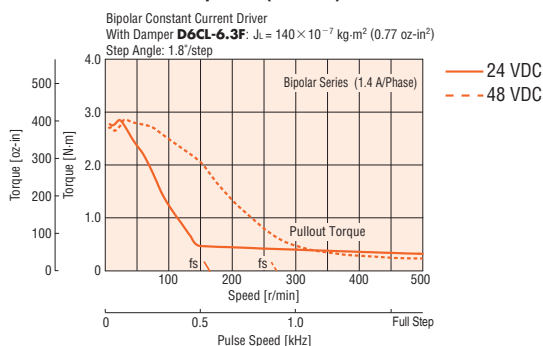

PV269-02BA Unipolar

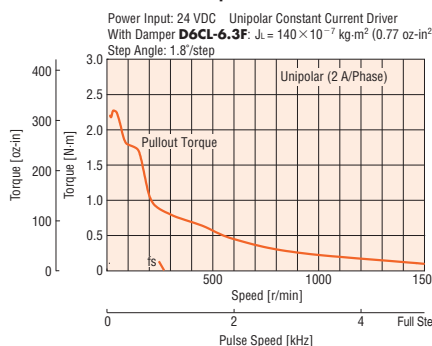

Note:

- Pay attention to heat dissipation from motor as there will be a considerable amount of heat under certain conditions. Be sure to keep the temperature of the motor case under 100°C (212°F).

85 mm (3.35 in.)

Step Angle 1.8°

PK Series Standard Type

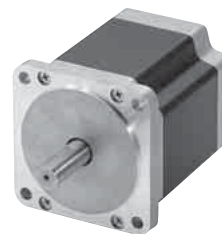

Specifications (RoHS)

Model	Connection Type	Holding Torque		Rated Current	Voltage	Resistance	Inductance	Rotor Inertia J		Lead Wires
		N-m	oz-in					kg-m ²	oz-in ²	
PK296-01AA PK296-01BA	Bipolar (Series) Unipolar	3.1 2.2	440 310	1.4 2	6.2 4.4	4.4 2.2	30.8 7.7	1400×10 ⁻⁷	7.7	6
PK296-02AA PK296-02BA	Bipolar (Series) Unipolar	3.1 2.2	440 310	2.1 3	4.2 3	2 1	14 3.5	1400×10 ⁻⁷	7.7	6
PK296-03AA PK296-03BA	Bipolar (Series) Unipolar	3.1 2.2	440 310	3.18 4.5	2.8 2	0.96 0.48	6 1.5	1400×10 ⁻⁷	7.7	6
PK296-F4.5A PK296-F4.5B	Bipolar (Parallel) Bipolar (Series) Unipolar	3.1 3.1 2.2	440 440 310	6.3 3.18 4.5	1.4 2.8 2	0.24 0.96 0.48	1.5 6 1.5	1400×10 ⁻⁷	7.7	8
PK299-01AA PK299-01BA	Bipolar (Series) Unipolar	6.2 4.4	880 620	1.4 2	9 6.4	6.4 3.2	56 14	2700×10 ⁻⁷	14.8	6
PK299-02AA PK299-02BA	Bipolar (Series) Unipolar	6.2 4.4	880 620	2.1 3	6 4.2	3 1.5	24 6	2700×10 ⁻⁷	14.8	6
PK299-03AA PK299-03BA	Bipolar (Series) Unipolar	6.2 4.4	880 620	3.18 4.5	3.9 2.8	1.32 0.66	10 2.5	2700×10 ⁻⁷	14.8	6
PK299-F4.5A PK299-F4.5B	Bipolar (Parallel) Bipolar (Series) Unipolar	6.2 6.2 4.4	880 880 620	6.3 3.18 4.5	1.9 3.9 2.8	0.33 1.32 0.66	2.5 10 2.5	2700×10 ⁻⁷	14.8	8
PK2913-01AA PK2913-01BA	Bipolar (Series) Unipolar	9.3 6.6	1320 930	1.4 2	10 7.6	7.6 3.8	76.8 19.2	4000×10 ⁻⁷	22	6
PK2913-02AA PK2913-02BA	Bipolar (Series) Unipolar	9.3 6.6	1320 930	2.8 4	5.3 3.8	1.94 0.97	16.8 4.2	4000×10 ⁻⁷	22	6
PK2913-F4.0A PK2913-F4.0B	Bipolar (Parallel) Bipolar (Series) Unipolar	9.3 9.3 6.6	1320 1320 930	5.6 2.8 4	2.6 5.3 3.8	0.49 1.94 0.97	4.2 16.8 4.2	4000×10 ⁻⁷	22	8

How to read specifications table → Page C-11

Wiring and connections → Page C-211

Dimensions Unit = mm (in.)

Model	L1	L2	Mass kg (lb.)	DXF
PK296-0□AA PK296-F4.5A	66 (2.60)	-	1.7 (3.7)	B122U
PK296-0□BA PK296-F4.5B		100 (3.94)		
PK299-0□AA PK299-F4.5A	96 (3.78)	-	2.8 (6.2)	B123U
PK299-0□BA PK299-F4.5B		130 (5.12)		
PK2913-0□AA PK2913-F4.0A	126 (4.96)	-	3.8 (8.4)	B124U
PK2913-0□BA PK2913-F4.0B		160 (6.30)		

Enter the winding specification in the box (□) within the model name.

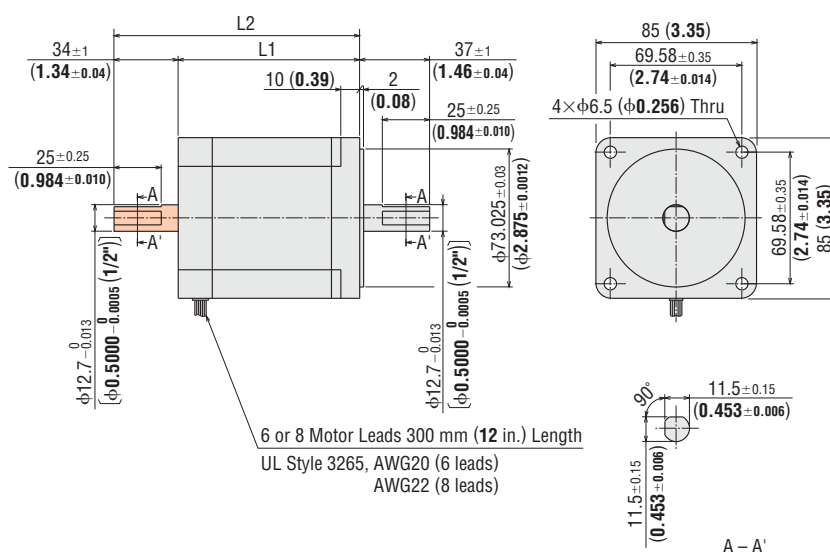

These dimensions are for the double shaft models. For the single shaft models, ignore the orange area.

- Introduction
- AC Input *Q5STEP AS*
- DC Input *Q5STEP ASG*
- 5-Phase Microstep *RK*
- AC Input 2-Phase Full/Half *UMK*
- 5-Phase Microstep *CMK*
- DC Input 2-Phase Microstep *RBK*
- 2-Phase Microstep *CMK*
- Without Encoder 2-Phase PK/PV
- With Encoder 2-Phase PK
- EMP400 Controllers
- SG8030U
- Accessories
- Installation

□ 28 mm
(1.10 in.)□ 35 mm
(1.38 in.)□ 42 mm
(1.65 in.)□ 50 mm
(1.97 in.)□ 56.4 mm
(2.22 in.)□ 60 mm
(2.36 in.)□ 85 mm
(3.35 in.)□ 90 mm
(3.54 in.)

Speed – Torque Characteristics

How to read speed – torque characteristics → Page C-12

PK296-01BA Bipolar (Series)

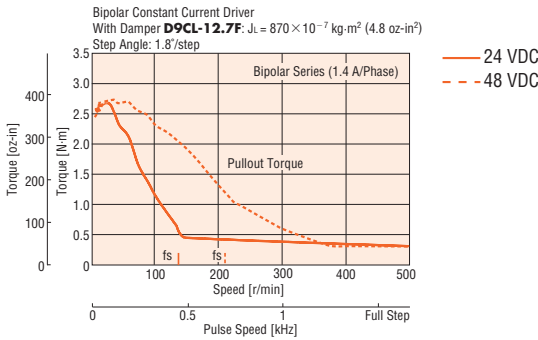

PK296-01BA Unipolar

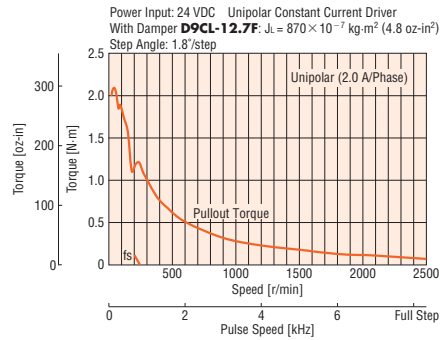

PK296-02BA Bipolar (Series)

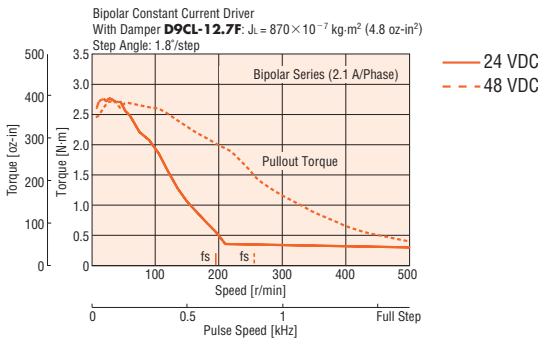

PK296-02BA Unipolar

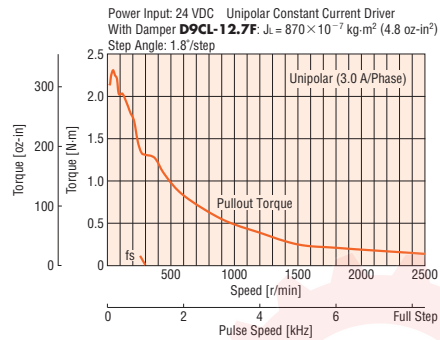

PK296-03BA Bipolar (Series)

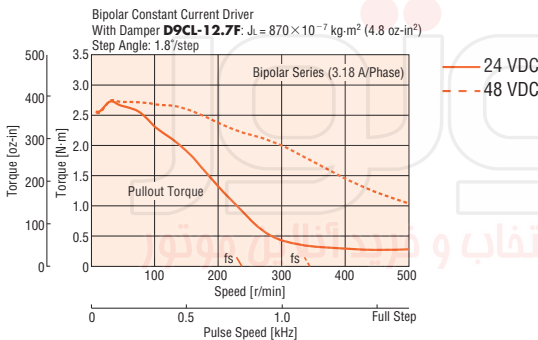

PK296-03BA Unipolar

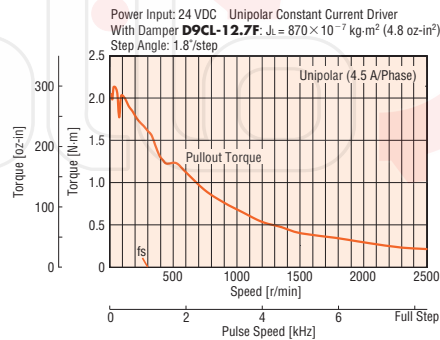

PK296-F4.5B Bipolar (Parallel)

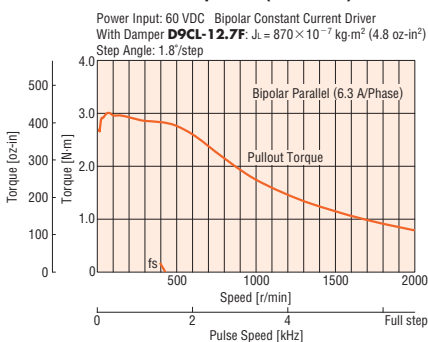

PK296-F4.5B Bipolar (Series)

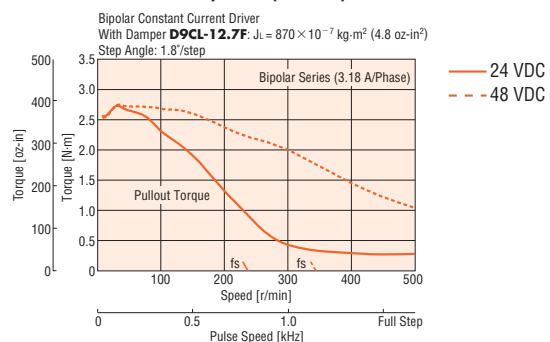

Note:

- Pay attention to heat dissipation from motor as there will be a considerable amount of heat under certain conditions. Be sure to keep the temperature of the motor case under 100°C (212°F).

PK299-01BA Bipolar (Series)

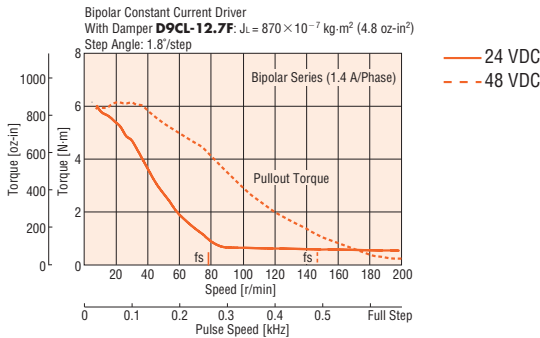

PK299-01BA Unipolar

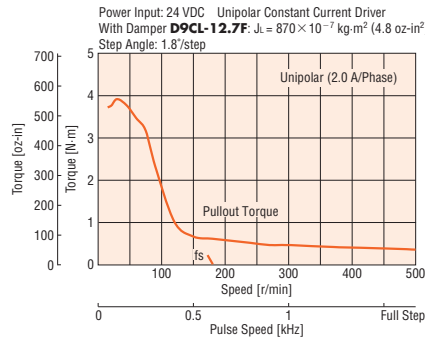

PK299-02BA Bipolar (Series)

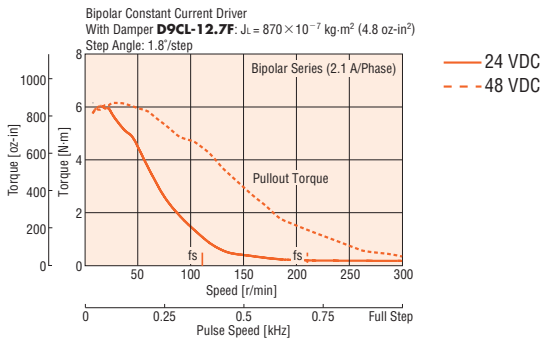

PK299-02BA Unipolar

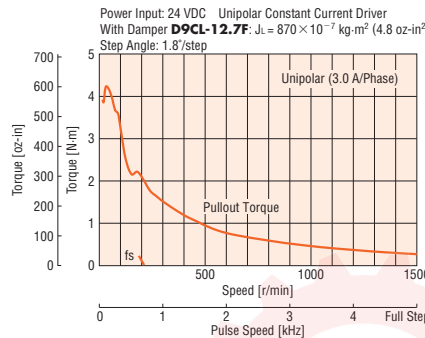

PK299-03BA Bipolar (Series)

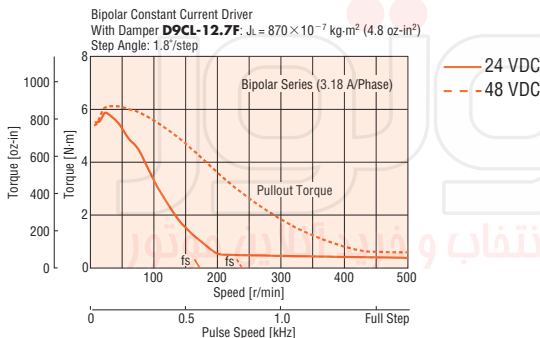

PK299-03BA Unipolar

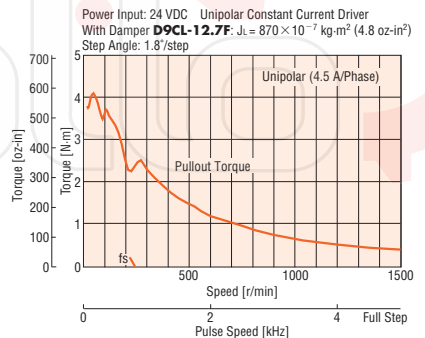

PK299-F4.5B Bipolar (Parallel)

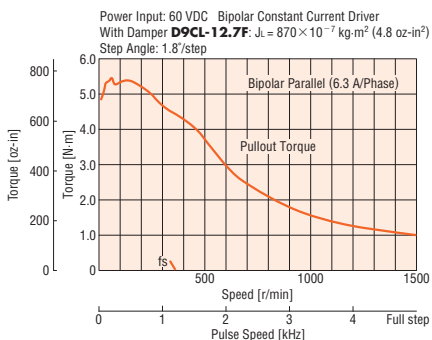

PK299-F4.5B Bipolar (Series)

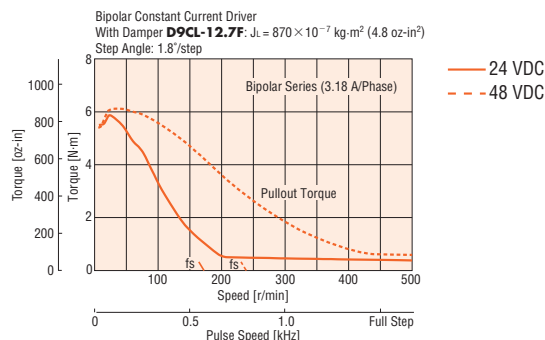

Note:

- Pay attention to heat dissipation from motor as there will be a considerable amount of heat under certain conditions. Be sure to keep the temperature of the motor case under 100°C (212°F).

Speed – Torque Characteristics

How to read speed – torque characteristics → Page C-12

PK2913-01BA Bipolar (Series)

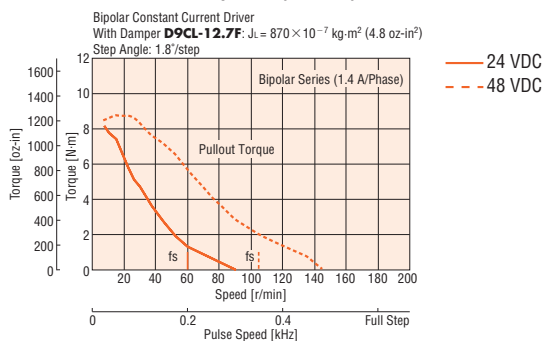

PK2913-01BA Unipolar

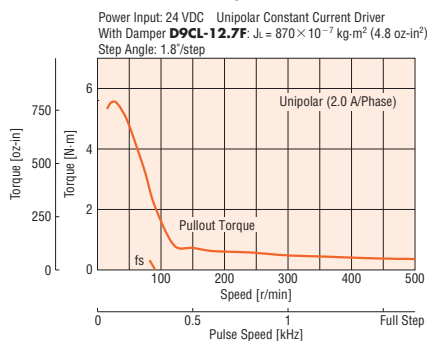

PK2913-02BA Bipolar (Series)

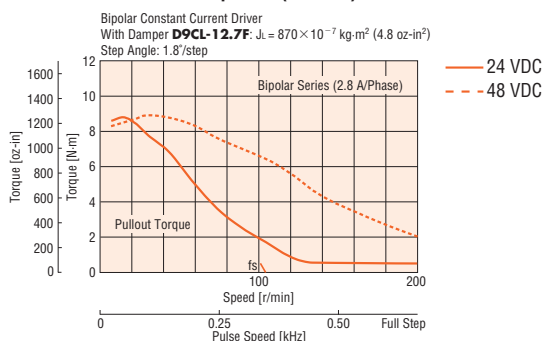

PK2913-02BA Unipolar

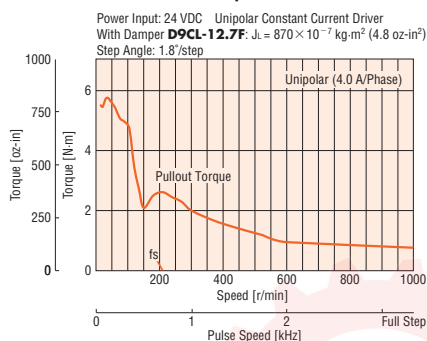

PK2913-F4.0B Bipolar (Parallel)

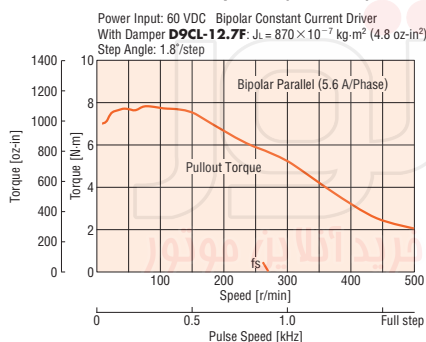

PK2913-F4.0B Bipolar (Series)

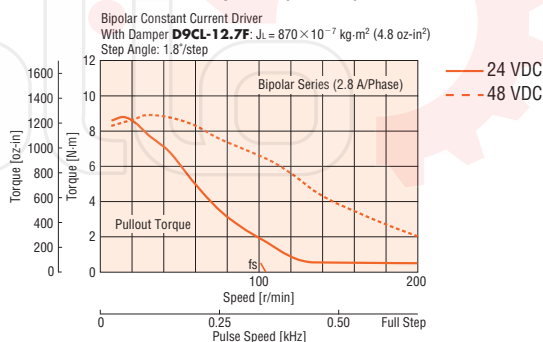

Note:

- Pay attention to heat dissipation from motor as there will be a considerable amount of heat under certain conditions. Be sure to keep the temperature of the motor case under 100°C (212°F).

85 mm (3.35 in.)

Step Angle 1.8°

PK Series Standard Type Terminal Box



Specifications (RoHS)



Model	Connection Type	Holding Torque		Rated Current	Voltage	Resistance	Inductance	Rotor Inertia J		Lead Wires (Terminals)	Corresponding DC-Input Motor & Driver Package
		N-m	oz-in					kg-m ²	oz-in ²		
PK296EAT	Bipolar (Parallel)	3.1	440	6.3	1.4	0.24	1.5	1400×10 ⁻⁷	7.7	8	RBK296T
	Bipolar (Series)	3.1	440	3.18	2.8	0.96	6.0				
	Unipolar	2.2	310	4.5	2	0.48	1.5				
PK299EAT	Bipolar (Parallel)	6.2	880	6.3	1.9	0.33	2.5	2700×10 ⁻⁷	14.8	8	RBK299T
	Bipolar (Series)	6.2	880	3.18	3.9	1.32	10.0				
	Unipolar	4.4	620	4.5	2.8	0.66	2.5				
PK2913EAT	Bipolar (Parallel)	9.3	1320	5.6	2.6	0.49	4.2	4000×10 ⁻⁷	22	8	RBK2913T
	Bipolar (Series)	9.3	1320	2.8	5.3	1.94	16.8				
	Unipolar	6.6	930	4	3.8	0.97	4.2				

How to read specifications table → Page C-11

Wirings and connections → Page C-211

List of safety standard approved products (model, standards, file no., certification body) → Page G-11

● Degree of protection: IP65*

* Excluding the gap between the shaft and the flange.

Dimensions Unit = mm (in.)

Model	L	Mass kg (lb.)	DXF
PK296EAT	110 (4.33)	2.1 (4.6)	B379
PK299EAT	140 (5.51)	3.2 (7)	B380
PK2913EAT	170 (6.69)	4.3 (9.5)	B381

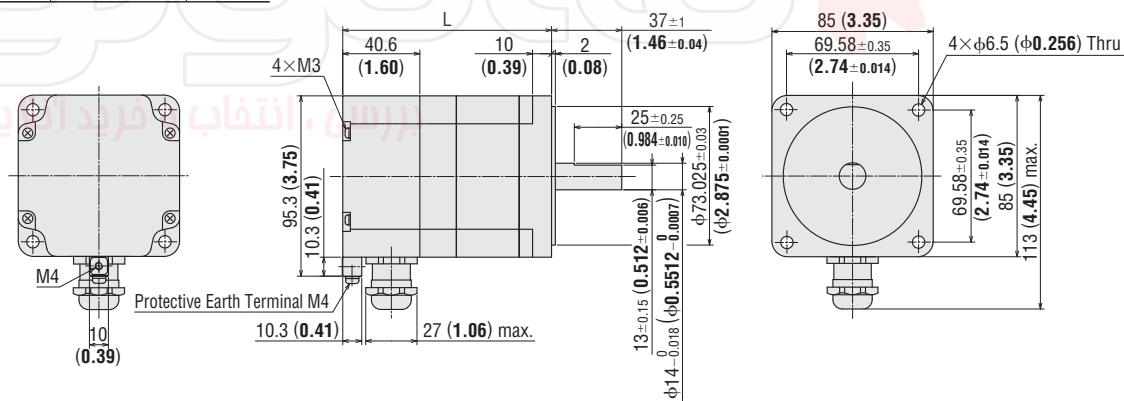

● Use cable (VCT) with a diameter of φ7~φ13 mm (φ0.28~φ0.51 in.). A motor cable is available as an accessory (sold separately). → Page C-298

Introduction

AC Input QSTEP AS

DC Input QSTEP ASC

5-Phase Microstep AC Input RK

2-Phase Full/Half UMK

5-Phase Microstep CMK

2-Phase Microstep RBK

2-Phase Microstep CMK

2-Phase PK/PV Without Encoder

2-Phase PK With Encoder

EMP400 Controllers

SG8030J

Accessories

Installation

Speed – Torque Characteristics

How to read speed – torque characteristics → Page C-12

PK296EAT Bipolar (Parallel)

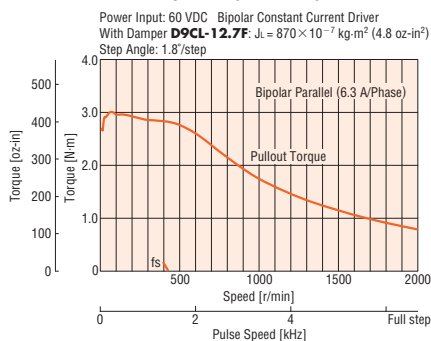

PK296EAT Bipolar (Series)

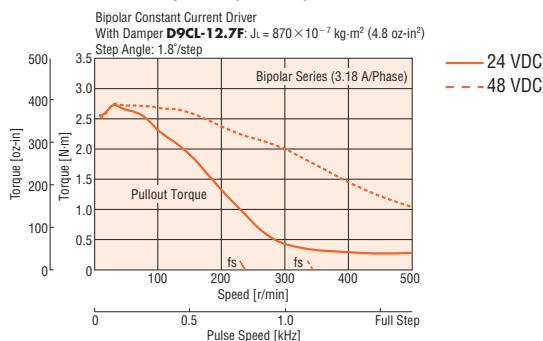

PK299EAT Bipolar (Parallel)

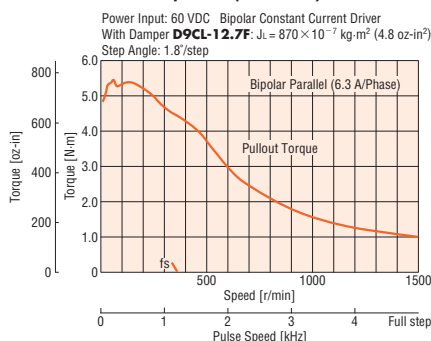

PK299EAT Bipolar (Series)

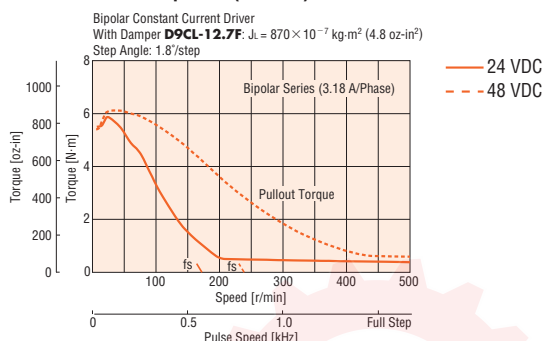

PK2913EAT Bipolar (Parallel)

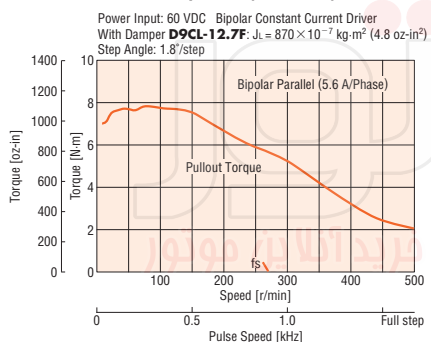

PK2913EAT Bipolar (Series)

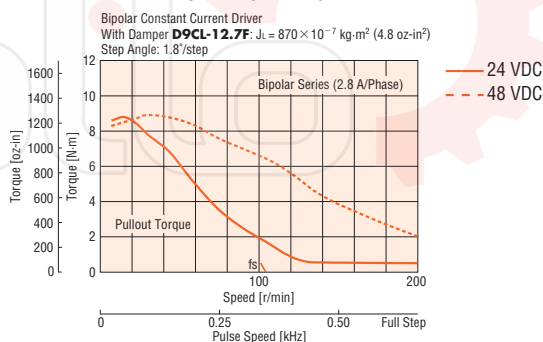

Note:

- Pay attention to heat dissipation from motor as there will be a considerable amount of heat under certain conditions. Be sure to keep the temperature of the motor case under 100°C (212°F).

90 mm (3.54 in.) PK Series SH Geared Type



Specifications (RoHS)

Motor Specifications

Model Single Shaft Double Shaft	Connection Type	Rated Current A/phase	Voltage VDC	Resistance Ω/phase	Inductance mH/phase	Rotor Inertia J		Lead Wires
						kg·m ²	oz·in ²	
PK296A1A-SG □	Bipolar (Series)	1	4.4	4.4	30.8	1400×10 ⁻⁷	7.7	6
PK296B1A-SG □	Unipolar	1.5	3.3	2.2	7.7			
PK296A2A-SG □	Bipolar (Series)	2.1	2	0.96	6	1400×10 ⁻⁷	7.7	6
PK296B2A-SG □	Unipolar	3	1.4	0.48	1.5			

How to read specifications table → Page C-11

Wirings and connections → Page C-211

● Enter the gear ratio in the box (□) within the model name.

Gearmotor Specifications

Model Single Shaft Double Shaft	Gear Ratio	Holding Torque*		Step Angle	Permissible Speed r/min
		N·m	lb·in		
PK296A1A-SG3.6, PK296A2A-SG3.6 PK296B1A-SG3.6, PK296B2A-SG3.6	3.6:1	2.5	22	0.5°	500
PK296A1A-SG7.2, PK296A2A-SG7.2 PK296B1A-SG7.2, PK296B2A-SG7.2	7.2:1	5	44	0.25°	250
PK296A1A-SG9, PK296A2A-SG9 PK296B1A-SG9, PK296B2A-SG9	9:1	6.3	55	0.2°	200
PK296A1A-SG10, PK296A2A-SG10 PK296B1A-SG10, PK296B2A-SG10	10:1	7	61	0.18°	180
PK296A1A-SG18, PK296A2A-SG18 PK296B1A-SG18, PK296B2A-SG18	18:1	9	79	0.1°	100
PK296A1A-SG36, PK296A2A-SG36 PK296B1A-SG36, PK296B2A-SG36	36:1	12	106	0.05°	50

* Holding torque is the same regardless of the connection type, due to the permissible torque limit of the gearhead.

Dimensions Unit = mm (in.)

Model	L1	L2	Mass kg (lb.)	DXF
PK296A □ A-SG □	126 (4.96)	-	2.8 (6.2)	B242U
PK296B □ A-SG □		160 (6.3)		

● Enter the winding specification in the box (□) within the model name.

Enter the gear ratio in the box (□) within the model name.

● Screws (Included)

1/4-20 UNC, Length 19 mm (0.75 in.)...4 pieces

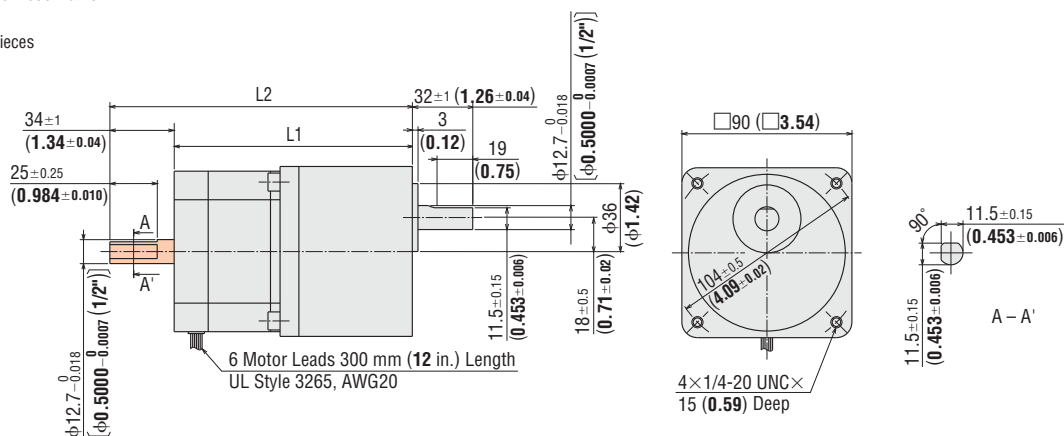

● These dimensions are for the double shaft models. For the single shaft models, ignore the orange area.

Speed – Torque Characteristics

How to read speed – torque characteristics → Page C-12

PK296B1A-SG □ Bipolar (Series) 24 VDC

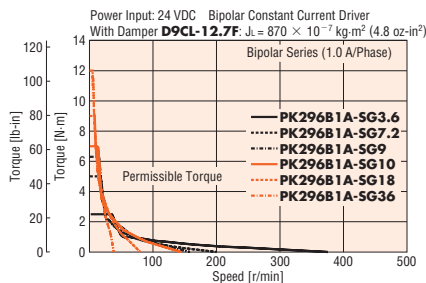

PK296B1A-SG □ Unipolar

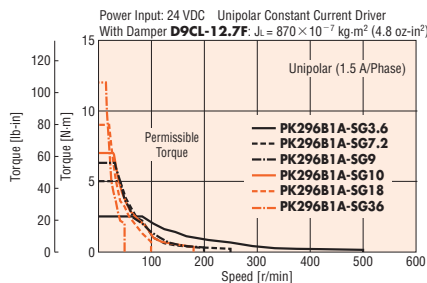

PK296A1B-SG □ Bipolar (Series) 48 VDC

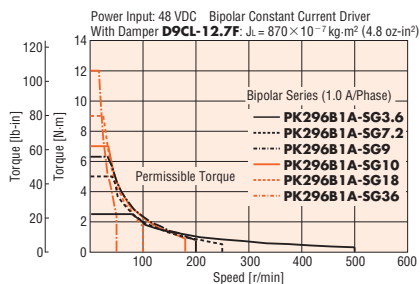

PK296B2A-SG □ Bipolar (Series) 24 VDC

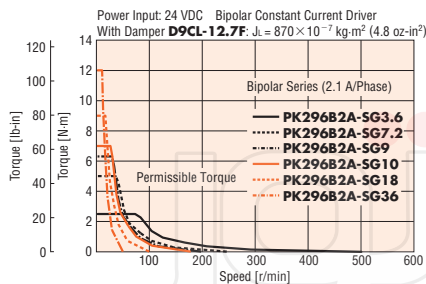

PK296B2A-SG □ Unipolar

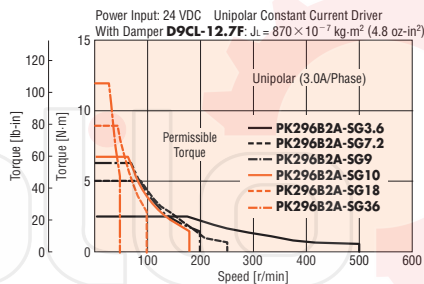

PK296B2A-SG □ Bipolar (Series) 48 VDC

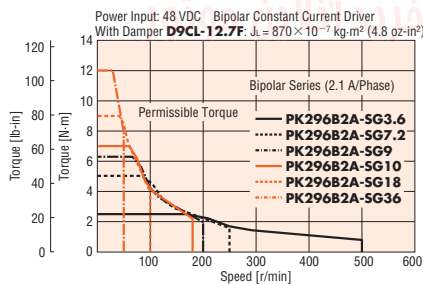

Note:

- Pay attention to heat dissipation from motor as there will be a considerable amount of heat under certain conditions. Be sure to keep the temperature of the motor case under 100°C (212°F).